

GMP J2 LASHER PARTS IDENTIFICATION GUIDE

for model series 86070

April 5, 2021

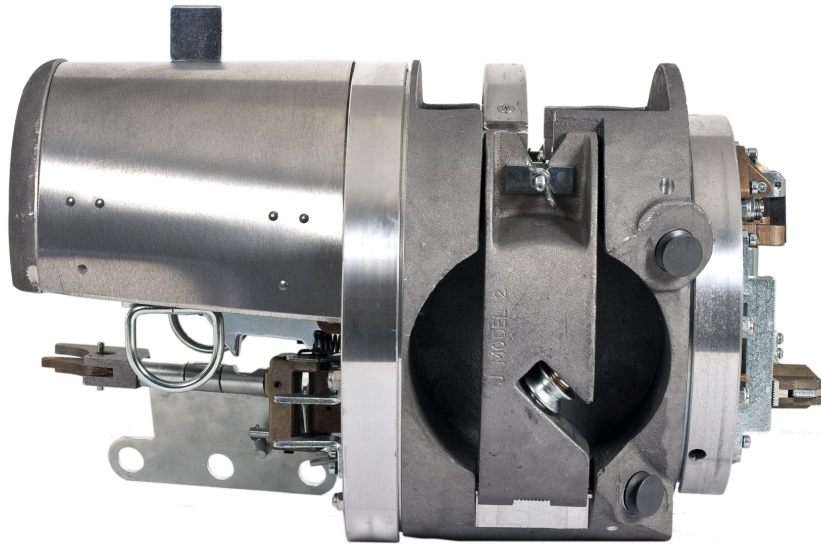

J2 Cable Lasher Parts Identification Guide

Contact: GMP 3111 Old Lincoln Hwy Trevose, PA 19053 USA

Tel: (215) 357-5500 Fax: (215) 357-6216

www.GMPtools.com

Note: Some Images may appear larger than they are for clarity purposes.

J2 parts kits and identification 03312021.pub
AK 4/5/2021

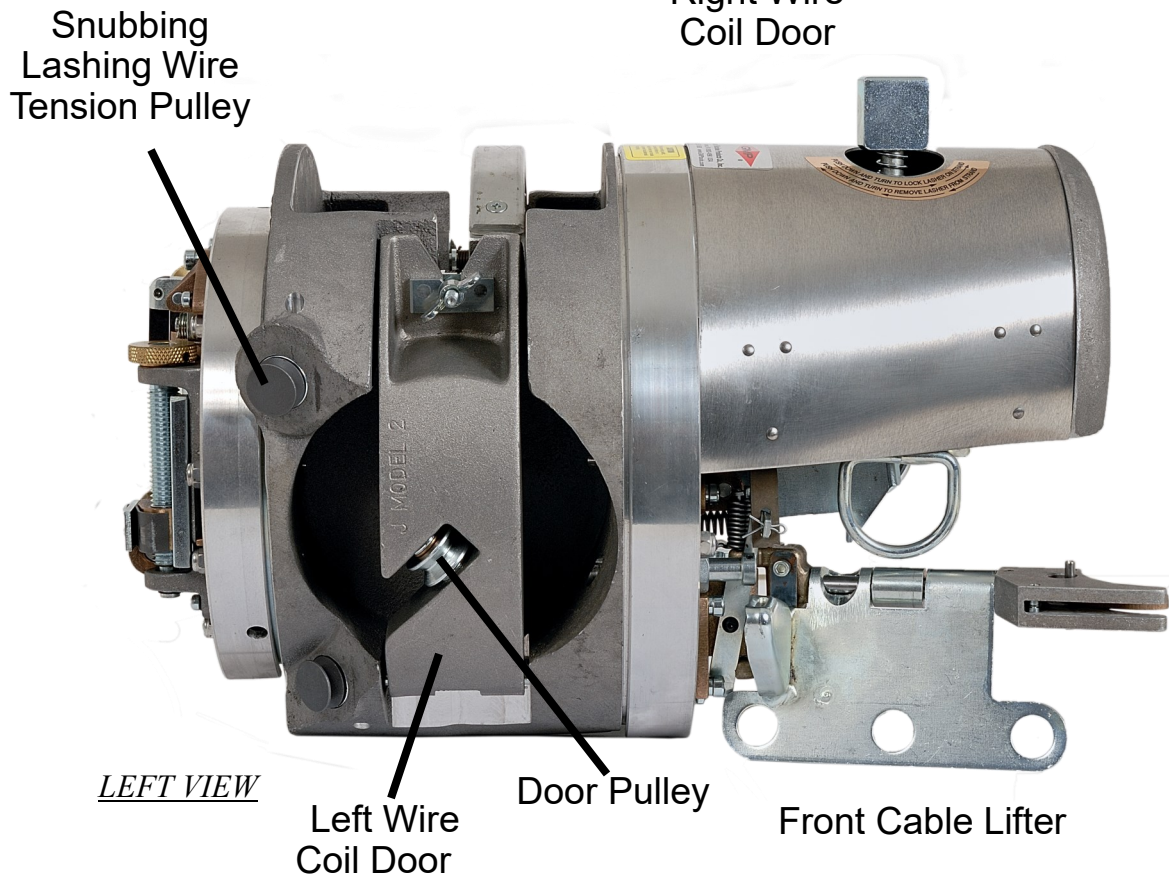
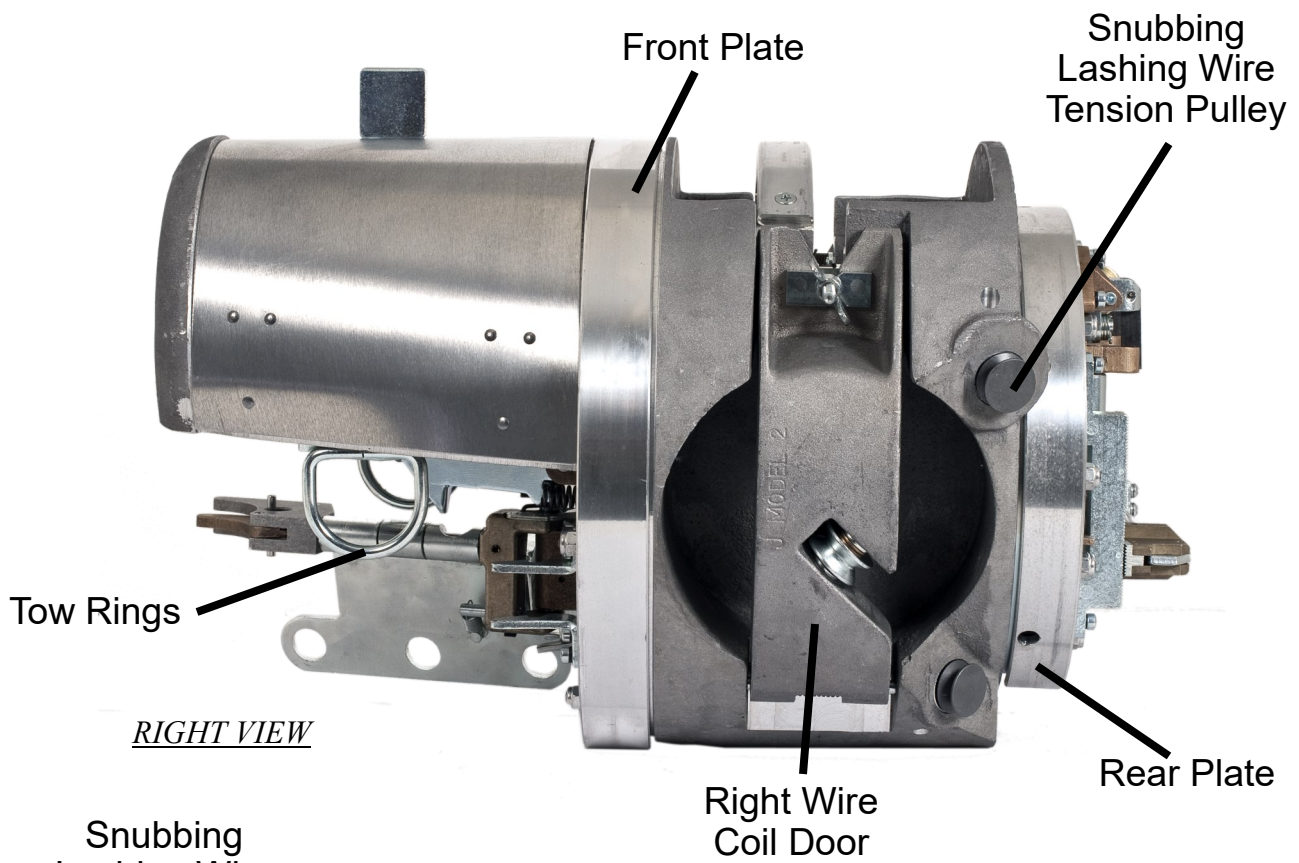

J2 Cable Lasher Parts Identification Guide

Contact: GMP 3111 Old Lincoln Hwy Trevose, PA 19053 USA
 Tel: (215) 357-5500 Fax: (215) 357-6216
 www.GMPtools.com

Note: Some Images may appear larger than they are for clarity purposes.

REAR VIEW

Snubbing
Lashing Wire
Tension Pulley

Vertical
Guide
Rollers

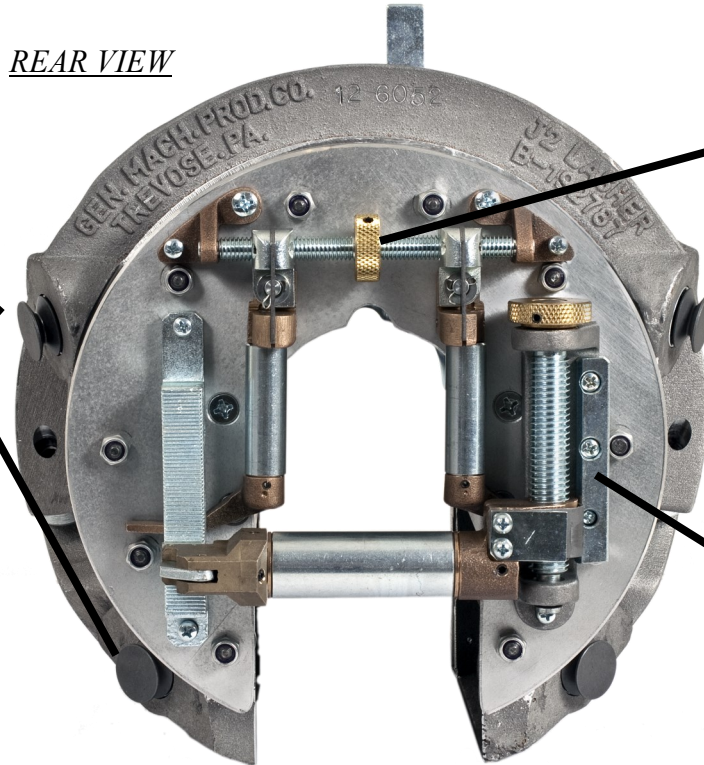

Rear Cable
Lifter

Drive
Wheels

Strand
Lock

Right Wire
Coil Door

Rear Strand
Roller

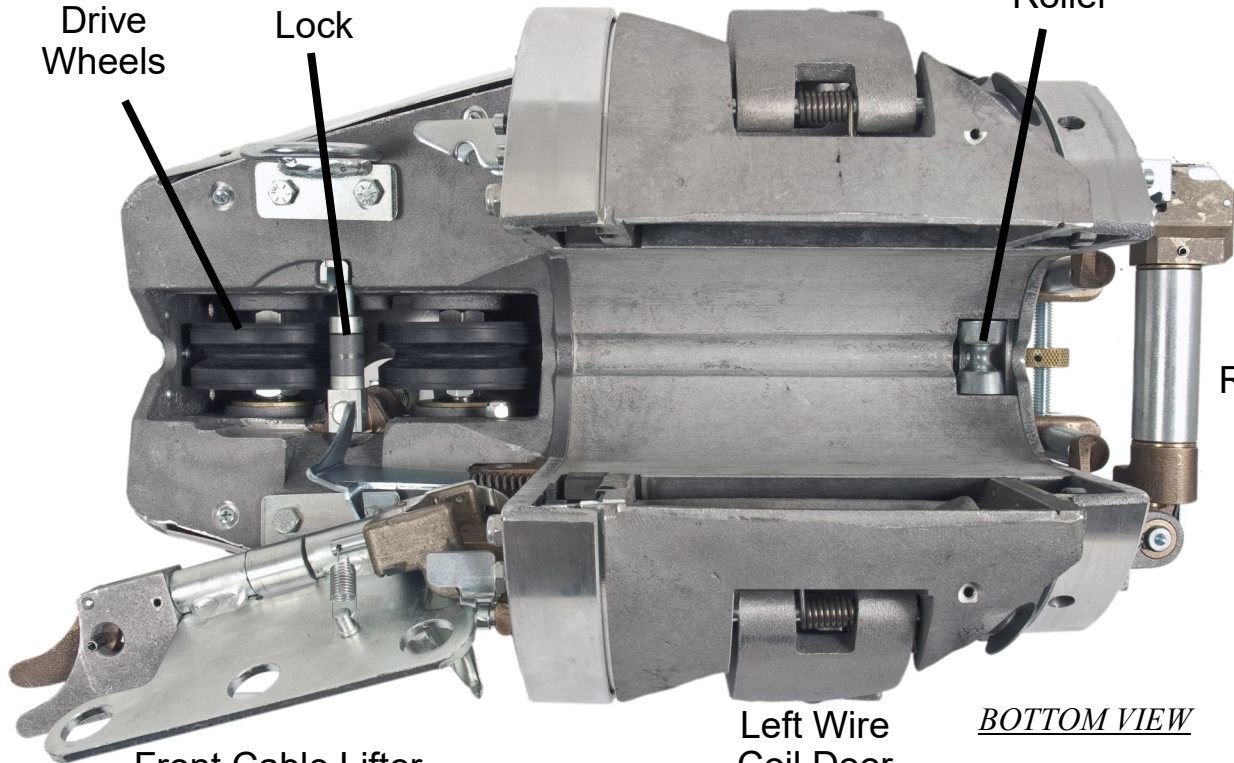

Rear Cable
Lifter

Front Cable Lifter

Left Wire
Coil Door

BOTTOM VIEW



J2 Cable Lasher Parts Identification Guide

Contact: GMP 3111 Old Lincoln Hwy Trevose, PA 19053 USA
Tel: (215) 357-5500 Fax: (215) 357-6216
www.GMPtools.com

Note: Some Images may appear larger than they are for clarity purposes.

J2 parts kits and identification 03312021.pub
AK 4/5/2021

PARTS LOCATOR

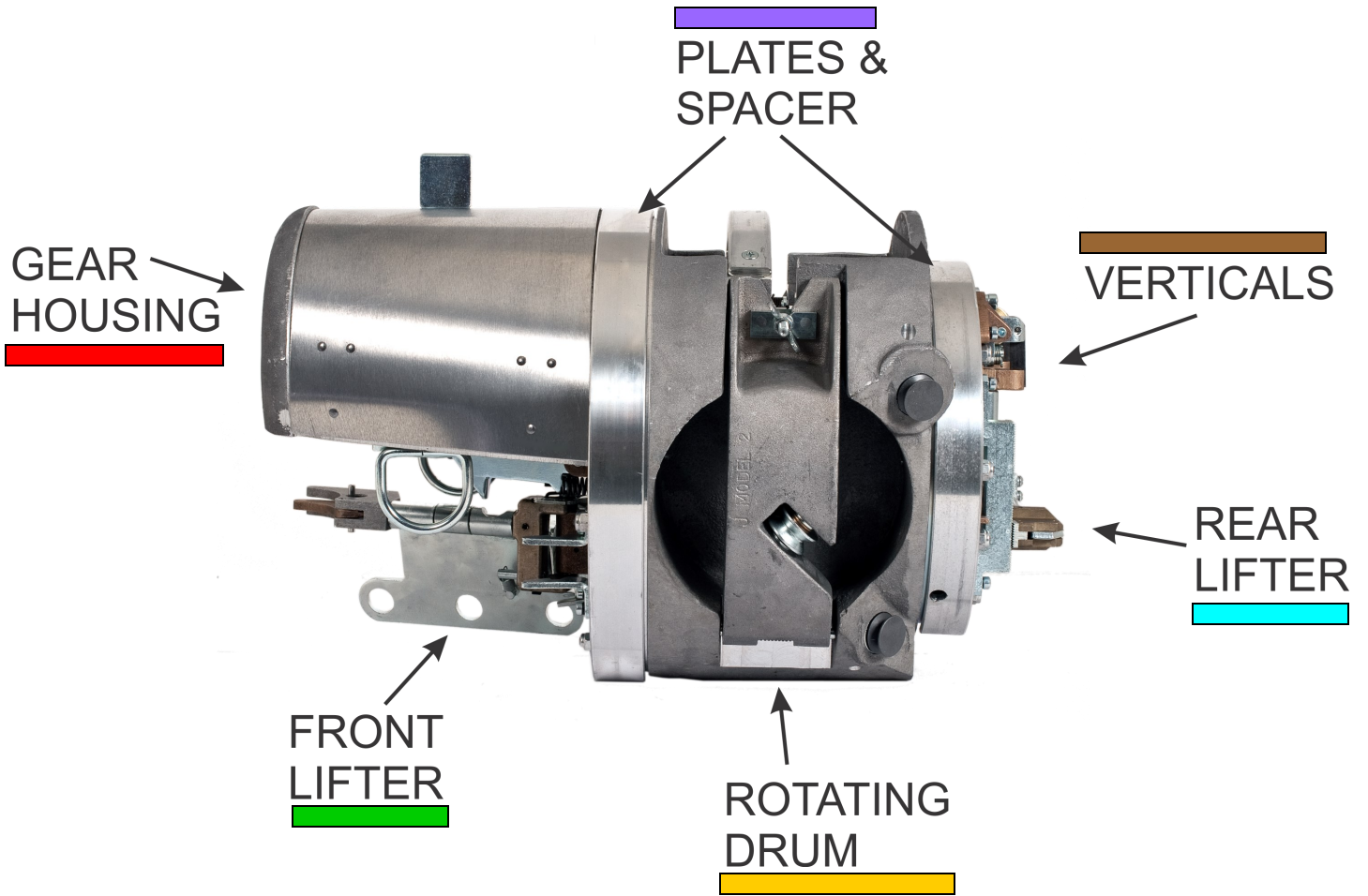

ACCESSORIES





J2 LASHER GEAR HOUSING

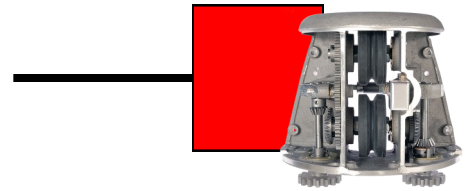

Gear Drive Housing Assy - J2
p/n 15349



Gear Drive Housing Assy - J2B
p/n 28145



Tapered Plug Kit - 10 Pack
p/n 33353



L.H. Pinion Assy Kit - J2
p/n 15172



R.H. Pinion Assy Kit - J2
p/n 07567

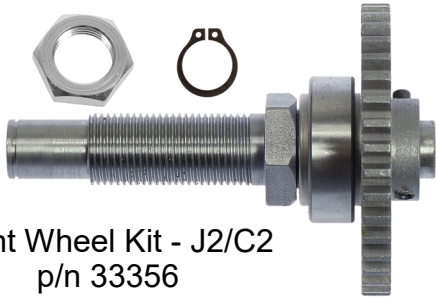

Front Wheel Kit - J2/C2
p/n 33356

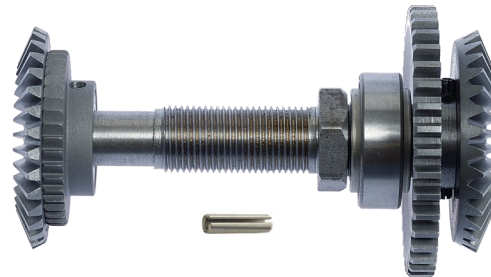

Rear Wheel Strand Drive - J2/C2
p/n 07558

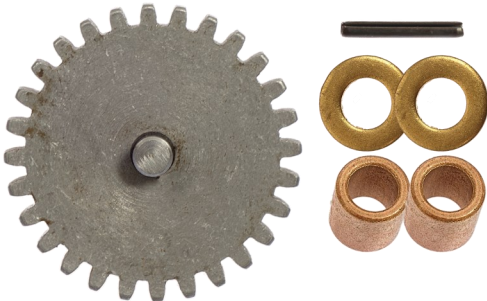

Idler Gear & Shaft Kit - J2/C2
p/n 33274



Gear Housing Bearing Kit - J2/C2
p/n 33358

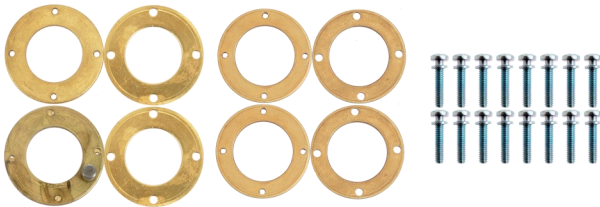

Bearing Retaining Kit - J2/C2
p/n 33272



Strand Wheel Kit - J2/C2
p/n 33359



J2 Cable Lasher Parts Identification Guide

Contact: GMP 3111 Old Lincoln Hwy Trevose, PA 19053 USA
Tel: (215) 357-5500 Fax: (215) 357-6216
www.GMPtools.com

Note: Some Images may appear larger than they are for clarity purposes.



J2 LASHER GEAR HOUSING

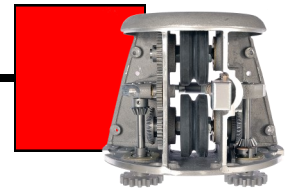

Ratchet Kit - J2
p/n 33355

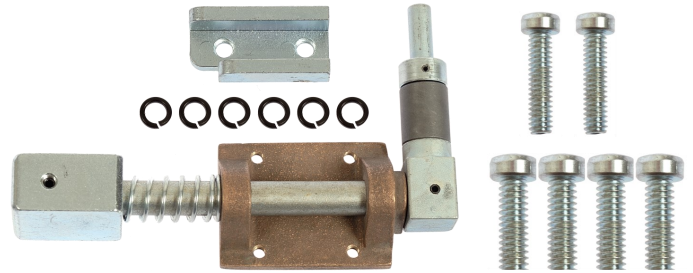

Tension Roller Kit - J2
p/n 33360



Lever Assembly Kit
p/n 33271



Cover Kit - J2
p/n 33357



Cover Kit w/o Hole - J2
p/n 33380



Handle Kit - J2 Lasher
p/n 33379



Tow Ring Hardware Kit - J2
p/n 28306



J2 Cable Lasher Parts Identification Guide

Contact: GMP 3111 Old Lincoln Hwy Trevose, PA 19053 USA
Tel: (215) 357-5500 Fax: (215) 357-6216
www.GMPtools.com

Note: Some Images may appear larger than they are for clarity purposes.

J2 parts kits and identification 03312021.pub
AK 4/5/2021



J2 LASHER ROTATING DRUM

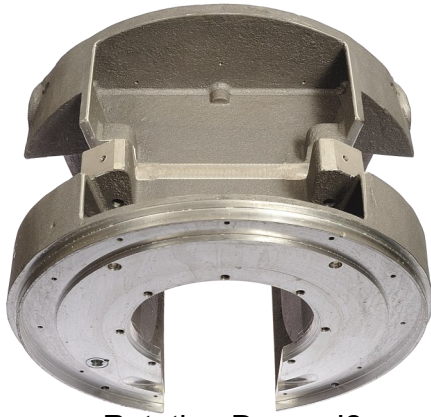
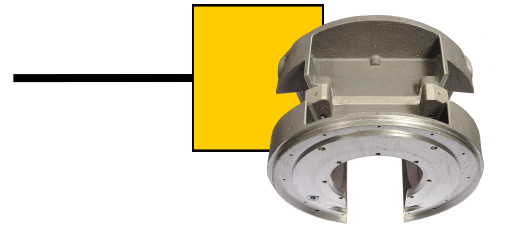

Rotating Drum -J2
p/n 03059



Snubbing Pulley Kit -J2
p/n 33362



Door Pulley Kit - J2
p/n 33361



casting # on door 192792 or 03262

Left Wire Coil Door
p/n 03062



casting # on door 192793 or 03070

Right Wire Coil Door
p/n 03070

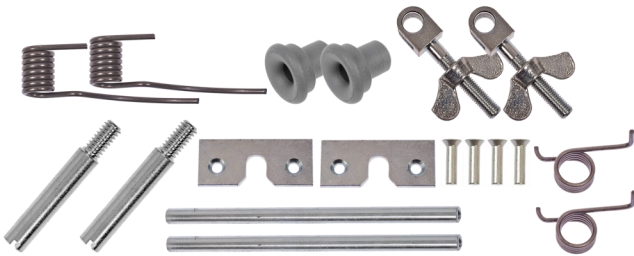

Door Accessory Kit -J2
p/n 33363



Swing Bolt Kit
p/n 34097



Ring Gear Kit
p/n 33277



Large Ring Kit
p/n 33278



Small Ring Kit
p/n 33280



Handle Kit
33279



J2 Cable Lasher Parts Identification Guide

Contact: GMP 3111 Old Lincoln Hwy Trevoese, PA 19053 USA
Tel: (215) 357-5500 Fax: (215) 357-6216
www.GMPtools.com

Note: Some Images may appear larger than they are for clarity purposes.

J2 parts kits and identification 03312021.pub
AK 4/5/2021



J2 LASHER SPACER AND PLATES

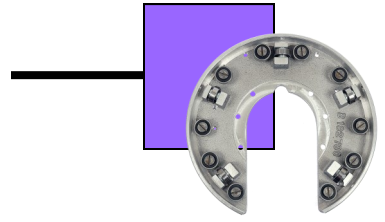

Front Plate Complete - J2
p/n 03084

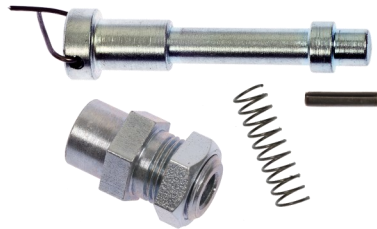

Plunger Kit - J2
p/n 33366



Angle Bracket Kit - J2
p/n 33282



Front Bearing Kit - J2
p/n 33354

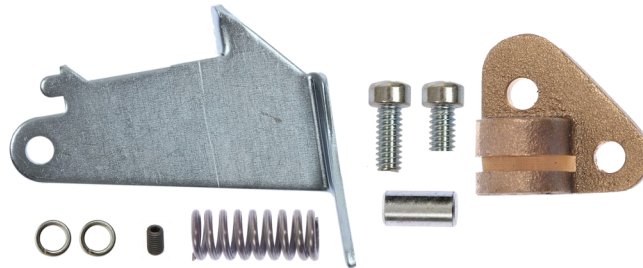

Pivot Plate Kit - J2
p/n 33364



Spacer Kit - J2
p/n 33368



Rear Plate Complete - J2
p/n 03094



Rear Bearing Kit - J2
p/n 33265



Trail Roller Kit - J2
p/n 33367



J2 Cable Lasher Parts Identification Guide

Contact: GMP 3111 Old Lincoln Hwy Trevose, PA 19053 USA
Tel: (215) 357-5500 Fax: (215) 357-6216
www.GMPtools.com

Note: Some Images may appear larger than they are for clarity purposes.



J2 LASHER FRONT LIFTER

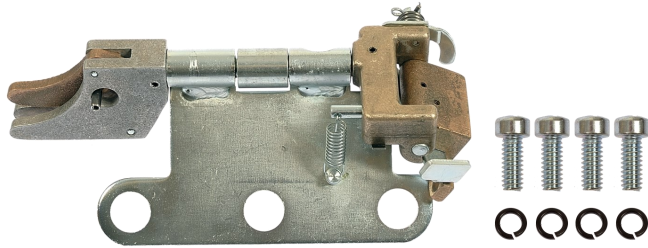
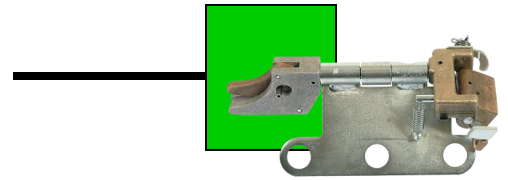

Front Lifter Kit - J2
p/n 33378

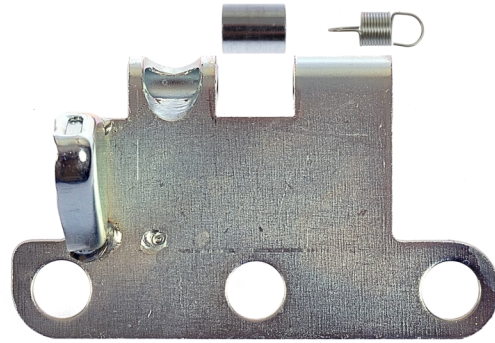

Tow Plate Kit - J2
p/n 33370



Hinge Pin Kit - J2
p/n 33369

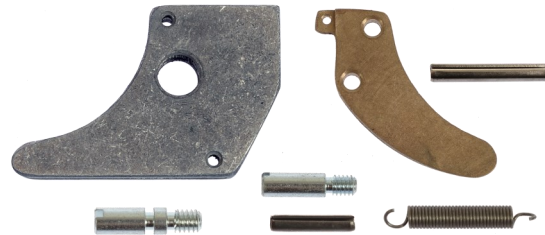

Locking Head Assy Kit - J2
p/n 33373

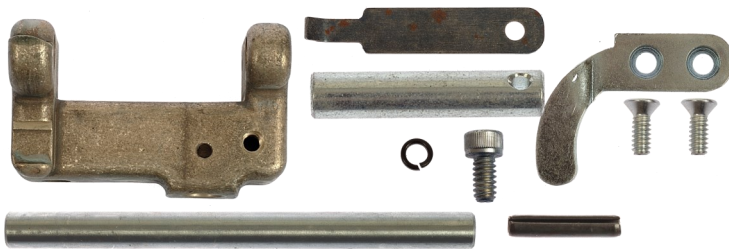

Support Casting Kit - J2
p/n 33372



J2 Cable Lasher Parts Identification Guide

Contact: GMP 3111 Old Lincoln Hwy Trevoese, PA 19053 USA
Tel: (215) 357-5500 Fax: (215) 357-6216
www.GMPtools.com

Note: Some Images may appear larger than they are for clarity purposes.

J2 parts kits and identification 03312021.pub
AK 4/5/2021



J2 LASHER REAR LIFTER

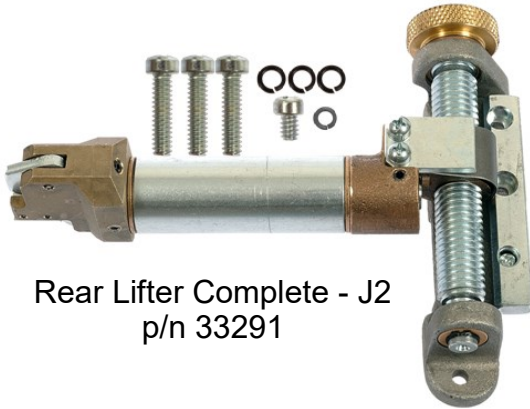
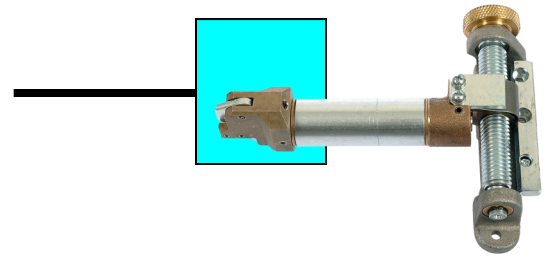

Rear Lifter Complete - J2
p/n 33291

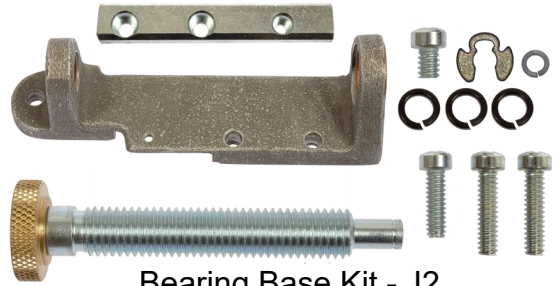

Bearing Base Kit - J2
p/n 33374

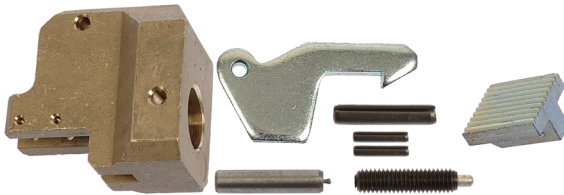

Head Assy Kit - J2
p/n 33376

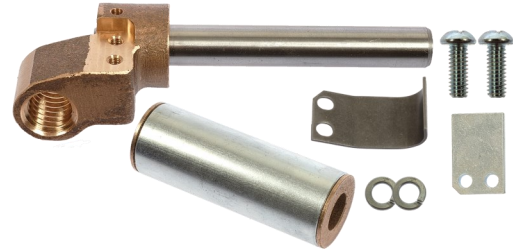

Thread Follower Kit - J2
p/n 33375



Fixed Pad Kit - J2
p/n 33287



J2 Cable Lasher Parts Identification Guide

Contact: GMP 3111 Old Lincoln Hwy Trevose, PA 19053 USA
Tel: (215) 357-5500 Fax: (215) 357-6216
www.GMPtools.com

Note: Some Images may appear larger than they are for clarity purposes.

J2 parts kits and identification 03312021.pub
AK 4/5/2021



J2 LASHER VERTICAL GUIDE

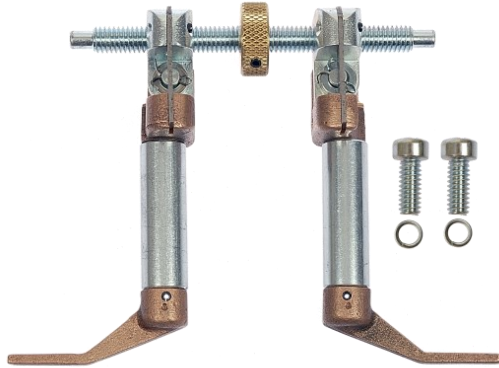
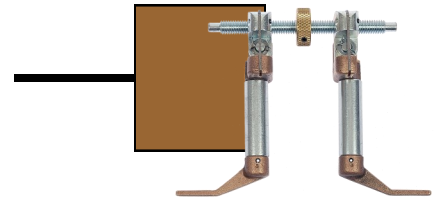

Vertical Assembly Kit - J2
p/n 33377



Mounting Bracket Kit - J2
p/n 33371



L.H. Vertical Sub Assy - J2
p/n 33232



R.H. Vertical Sub Assy - J2
p/n 33231



J2 Cable Lasher Parts Identification Guide

Contact: GMP 3111 Old Lincoln Hwy Trevose, PA 19053 USA
Tel: (215) 357-5500 Fax: (215) 357-6216
www.GMPtools.com

Note: Some Images may appear larger than they are for clarity purposes.

J2 parts kits and identification 03312021.pub
AK 4/5/2021



J2 LASHER MISCELLANEOUS

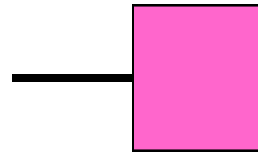

Storage & Transport Chest - J2
p/n 08189



Bridle Rope Assembly - J2/C2
p/n 03165



Towing Lanyard 35' Long - J2/C2
p/n 70190



J2 Cable Lasher Parts Identification Guide

Contact: GMP 3111 Old Lincoln Hwy Trevose, PA 19053 USA
Tel: (215) 357-5500 Fax: (215) 357-6216
www.GMPtools.com

Note: Some Images may appear larger than they are for clarity purposes.

J2 parts kits and identification 03312021.pub
AK 4/5/2021

Parts

id	name	id	name
03059	Rotating Drum	33355	Ratchet Kit - J2
03062	Left Wire Coil Door Assembly	33356	Front Wheel Kit - J2
03070	Right Wire Coil Door	33357	Cover Kit
03084	Front Plate Complete with Bearings	33358	Gear Housing Bearing Kit - J2
03094	Rear Plate w/Bearings	33359	Stand Drive Wheel Kit -J2
03165	Bridle Rope Assembly	33360	Tension Roller Kit
07558	Rear Wheel Stand Drive Assy. - J2	33361	Door Pulley Kit - J2
07567	R. H. Pinion Assy. - J2	33362	Snubbing Pulley Kit -J2
08189	Storage and transport Chest for	33363	Door Accessory Kit - J2
15172	L. H. Pinion Assy. - J2	33364	Pivot Plate Kit - J2
15349	Drive Housing Assembly - J2	33365	Rear Bearing Kit - J2
28145	Drive Housing for J2B Multi Bundle Overlash	33366	Plunger Kit -J2
28306	Tow Rings and Mounting Kit - J2	33367	Trail Roller Kit - J2
33231	R.H Vertical Roller Sub Assy	33368	Spacer Kit - J2
33232	L.H Vertical Roller Sub Assy Complete	33369	Hinge Pin Kit - J2
33271	Lever Assembly Kit	33370	Tow Plate Kit - J2
33272	Bearing Retaining Ring Kit - J2	33371	Mounting Bracket Kit - J2
33274	Idler Gear and Shaft Kit - J2	33372	Support Casting Kit
33277	Ring Gear and Mounting Hardware Kit	33373	Locking Head Assembly Kit
33278	Large Ring Kit	33374	Bearing Base Kit - J2
33279	Handle Kit	33375	Threaded Follower Kit - J2
33280	Small Bearing Ring and Mounting Hardware Kit	33376	Head Assembly Kit - J2
33282	Angle Bracket Kit	33377	Vertical Assembly Kit - J2
33287	Fixed Pad Kit	33378	Front Lifter Kit Complete
33291	Rear Lifter Complete w/Mounting Hardware Kit	33379	Handle Kit
33353	Tapered Plug Kit - 10 Pack	33380	Cover Kit without hole for J2B
33354	Front Bearing Kit - J2	34097	Swing Bolt Kit
		70190	Towing Lanyard 35'



J2 Cable Lasher Parts Identification Guide

Contact: GMP 3111 Old Lincoln Hwy Trevose, PA 19053 USA

Tel: (215) 357-5500 Fax: (215) 357-6216

www.GMPtools.com

Note: Some Images may appear larger than they are for clarity purposes.

J2 parts kits and identification 03312021.pub
AK 4/5/2021

KIT COMPONENTS



ITEM# 15349
GEAR DRIVE HOUSING ASSY

USED IN: J2 GEAR HOUSING
THIS KIT CONSISTS OF:
1 PLATE J2 LASHER
1 CASTING
2 INSERT 5/16-18
3 RVT .125 X .500 AL



ITEM# 28145
GEAR DRIVE HOUSING ASSY J2B

USED IN: J2 GEAR HOUSING
THIS KIT CONSISTS OF:
1 CASTING
2 INSERT 5/16-18



ITEM# 33353
TAPERED PLUG KIT

USED IN: J2/C2 GEAR HOUSING
THIS KIT CONSISTS OF:
10 TAPERED PLUG



ITEM# 15172
L.H. PINION ASSEMBLY

USED IN: J2 GEAR HOUSING
THIS KIT CONSISTS OF:
1 LATCH
1 COLLAR
1 SHAFT
1 GEAR SPUR
2 RETAINING RING
1 PIN ROLL 156 0875
1 SSET 8-32X .18
1 GEAR PINION BEVEL



ITEM# 07567
R.H. PINION ASSEMBLY

USED IN: J2 GEAR HOUSING
THIS KIT CONSISTS OF:
1 SHAFT LASHER
1 GEAR SPUR
1 COLLAR LASHER
1 RETAINING RING
1 SSET 8-32X .37
1 PIN ROLL 156 0875
1 GEAR PINION



ITEM# 07558
REAR WHEEL STRAND DRIVE

USED IN: J2 GEAR HOUSING
THIS KIT CONSISTS OF:
1 RATCHET LASHER
1 SHAFT 7/8
1 BEARING 88013
1 PIN ROLL 156 1125
1 GEAR BEVEL
1 GEAR COMBIN.



ITEM# 33356
FRONT WHEEL KIT

USED IN: J2/C2 GEAR HOUSING
THIS KIT CONSISTS OF:
1 NUT
1 RETAINING RING
1 SHAFT ASSEMBLY

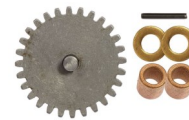

ITEM# 33274
IDLER GEAR AND SHAFT KIT

USED IN: J2/C2 DRIVE HOUSING
THIS KIT CONSISTS OF:
2 BEARING OILITE
1 PIN ROLL 094 0500
1 SHAFT & GEAR
2 WASHER .265 FLT



ITEM# 33358
GEAR HOUSING BEARING KIT

USED IN: J2/C2 DRIVE HOUSING
THIS KIT CONSISTS OF:
2 BEARING 88013
4 BEARING 88500



ITEM# 33272
BEARING RETAINING RING KIT

USED IN: J2/C2 DRIVE HOUSING
THIS KIT CONSISTS OF:
1 COVER WASHER
2 COVER WASHER
2 COVER WASHER
2 COVER WASHER
16 WA 5 LOK ST ZN
16 SMCH 5-40X .62
1 PLATE STOP



ITEM# 33359
STRAND DRIVE WHEEL KIT

USED IN: J2/C2 DRIVE HOUSING
THIS KIT CONSISTS OF:
2 NT BLOCK SPEC
2 STRAND DRIVE WHEEL
4 WA CLAMPING



ITEM# 33355
RATCHET KIT

USED IN: DRIVE HOUSING
THIS KIT CONSISTS OF:
1 BOLT SHOULDER
1 SPRING MUSIC WIRE
1 SCREW NECKED
1 TUBE RUBBER J2
1 WA 8 LOK ST ZN MD
1 NT .250-20 HX ST
1 LEVER & PIN

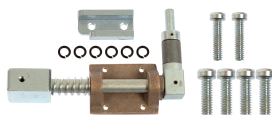

ITEM# 33360
TENSION ROLLER KIT

USED IN: J2 DRIVE HOUSING
THIS KIT CONSISTS OF:
1 STOP STRAND
6 WA 10 LOK
4 SMCH 10-32X .50
1 ROLLER STRAND
2 SMCH 10-24X .87



ITEM# 33271
LEVER ASSY KIT

USED IN: J2 DRIVE HOUSING
THIS KIT CONSISTS OF:
1 BRACKET
2 SPACER RECT
1 WIPER J2 LASHER
1 SMCH 4-40X .18



ITEM# 33357
COVER KIT

USED IN: J2 DRIVE HOUSING
THIS KIT CONSISTS OF:
1 COVER ASSY
4 SMCH 10-32X1.25



ITEM# 33380
COVER KIT WITH HOLE

USED IN: J2B DRIVE HOUSING
THIS KIT CONSISTS OF:
1 COVER
4 SMCH 10-32X1.25



J2 Cable Lasher Parts Identification Guide

Contact: GMP 3111 Old Lincoln Hwy Trevose, PA 19053 USA
Tel: (215) 357-5500 Fax: (215) 357-6216
www.GMPtools.com

Note: Some Images may appear larger than they are for clarity purposes.

KIT COMPONENTS



ITEM# 33379
HANDLE KIT

USED IN: J2 DRIVE HOUSING
THIS KIT CONSISTS OF:
1 HANDLE
2 THUMB SCREWS



ITEM# 28306
TOW RING HARDWARE KIT

USED IN: J2 DRIVE HOUSING
THIS KIT CONSISTS OF:
4 NT .250-28 HX
4 SCAP 250-28X1.12 T
2 PLATE
2 WELDMENT TOW



ITEM# 03059
ROTATING DRUM ASSY

USED IN: ROTATING DRUM
THIS KIT CONSISTS OF:
1 CASTING
1 SET 8-32X .31
1 BUSHING



ITEM# 33362
SNUBBING PULLEY KIT

USED IN: ROTATING DRUM ASSY
THIS KIT CONSISTS OF:
4 SSET 8-32X .37
4 PULLEY ASSY SNUBBING



ITEM# 33361
DOOR PULLY KIT

USED IN: ROTATING DRUM
THIS KIT CONSISTS OF:
2 TUBE LASHER
2 PIN COTTER 125X .750
2 PULLEY & BUSHING



ITEM# 03062
LEFT WIRE COIL DOOR

USED IN: ROTATING DRUM
THIS KIT CONSISTS OF:
1 COVER
1 TUBE LASHER
1 PULLEY LASHER
2 BEARING
1 BUSHING
1 PLATE
2 WA .387 FLT
1 PIN COTTER
2 RVT .125X .500



ITEM# 03070
RIGHT WIRE COIL DOOR

USED IN: ROTATING DRUM
THIS KIT CONSISTS OF:
1 TUBE LASHER
1 PULLEY LASHER
2 BEARING LOWER
1 BUSHING WIRE COIL
1 PLATE LASHER
2 WA .387 FLT ST ZN
1 COVER
1 PIN COTTER 125X .750
2 RVT .125X .500

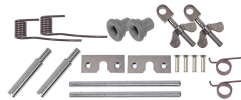

ITEM# 33363
DOOR ACCESSORY KIT

USED IN: ROTATING DRUM
THIS KIT CONSISTS OF:
2 BUSHING WIRE COIL
2 PLATE LASHER
2 SPRG
2 TUBE LASHER
2 SCREW
2 SPRING DOOR
4 WASHER
2 BOLT WING NUT
4 RVT .125X .500



ITEM# 34097
SWING BOLT KIT

USED IN: ROTATING DRUM
THIS KIT CONSISTS OF:
2 SWING BOLTS
2 SPRINGS



ITEM# 33277
RING GEAR AND HARDWARE

USED IN: ROTATING DRUM
THIS KIT CONSISTS OF:
1 GEAR RING
7 SMCH 250-20X .75
7 WA .250 LOK



ITEM# 33278
LARGE RING KIT

USED IN: ROTATING DRUM
THIS KIT CONSISTS OF:
1 RING LARGE
11 WA 6 LOK
11 SMCH 6-32X .37



ITEM# 33280
SMALL RING KIT

USED IN: ROTATING DRUM
THIS KIT CONSISTS OF:
1 RING SMALL
16 WA 6 LOK ST
16 SMCH 6-32X .37



ITEM# 33279
HANDLE KIT

USED IN: ROTATING DRUM
THIS KIT CONSISTS OF:
1 HANDLE
2 SMCH 10-24X .75 FL ST



ITEM# 03084
FRONT PLATE COMPLETE

USED IN: SPACER & PLATES
THIS KIT CONSISTS OF:
1 PLATE FRONT
1 NT LOCKING BOLT
1 SPRING
1 BUSHING
8 SCREW ECCENTRIC
1 BRACKET ANGLE
1 BRACKET ANGLE LEF
4 WA 10 LOK ST HI MD
8 NT .250-28 HX ST
4 SMCH 10-24X .50
1 PIN ROLL 125 0625
1 BOLT LOCKING
1 WA .250 LOK ST ZN MD
8 BEARING RAD 608
16 SPACER BEARING
1 SCAP 250-20X .50 HX
6 SMCH 250-20X .75 FL



ITEM# 33366
PLUNGER KIT

USED IN: SPACER & PLATES
THIS KIT CONSISTS OF:
1 SPRING
1 PIN ROLL 125 0625
1 BOLT LOCKING
1 HOUSING LOCK PIN



ITEM# 33282
ANGLE BRACKET KIT

USED IN: SPACER & PLATES
THIS KIT CONSISTS OF:
1 RT BRACKET
1 LFT BRACKET
4 WA 10 LOK ST
4 SMCH 10-24X .50



ITEM# 33354
FRONT BEARING KIT

USED IN: SPACER & PLATES
THIS KIT CONSISTS OF:
8 ECCENTRIC SCREW
8 NUT
8 BEARING
16 SPACER



J2 Cable Lasher Parts Identification Guide

Contact: GMP 3111 Old Lincoln Hwy Trevose, PA 19053 USA
Tel: (215) 357-5500 Fax: (215) 357-6216
www.GMPtools.com

Note: Some Images may appear larger than they are for clarity purposes.

KIT COMPONENTS



ITEM# 33364
PIVOT PLATE KIT

USED IN: SPACER & PLATES
THIS KIT CONSISTS OF:
1 PIVOT J2 LASHER
1 PIN 5/16 J2
1 SPRING
1 PIVOT PLATE
1 SSET 5-40X .18
1 SMCH 250-20X .50
1 SMCH 250-20X .62
2 WA .250 LOK ST



ITEM# 03094
REAR PLATE COMPLETE

USED IN: SPACER & PLATES
THIS KIT CONSISTS OF:
10 SCREW ECCENTRIC
1 PLATE REAR
10 NT .250-28 HX
5 SCREW SPEC SLOT
15 BEARING RAD 608
30 SPACER BEARING
6 SMCH 250-20X .75 FL

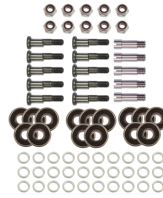

ITEM# 33365
REAR BEARING KIT

USED IN: SPACER & PLATES
THIS KIT CONSISTS OF:
10 SCREW ECCENTRIC
10 NT .250-28 HX
5 SCREW SPEC
15 BEARING RAD 608
30 SPACER BEARING



ITEM# 33368
SPACER KIT

USED IN: SPACER & PLATES
THIS KIT CONSISTS OF:
12 SMCH 250-20X .75
1 SPACER



ITEM# 33367
TRAIL ROLLER KIT

USED IN: SPACER & PLATES
THIS KIT CONSISTS OF:
1 PIN J2 LASHER
2 SSET 6-32X .25
1 STRAND PULLEY

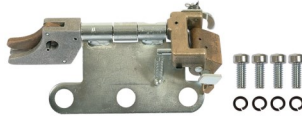

ITEM# 33378
FRONT LIFTER KIT

USED IN: FRONT LIFTER
THIS KIT CONSISTS OF:
1 FRONT CABLE LIFTER
4 SCREW 250-20X .62
4 SCREW LOCK WA

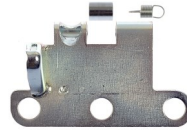

ITEM# 33370
TOW PLATE KIT

USED IN: FRONT LIFTER
THIS KIT CONSISTS OF:
1 Sleeve
1 Spring
1 Tow Plate

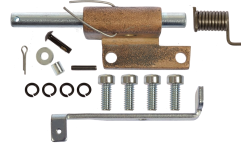

ITEM# 33369
HINGE PIN KIT

USED IN: FRONT LIFTER
THIS KIT CONSISTS OF:
1 CABLE LIFTER BRACKET
1 TORSION SPRING
1 COTTER PIN 3/32 X 1/2
4 SCREW 1/4 X 20 X 5/8
1 ROLL PIN 1/8 X 9/16
1 HINGE/PIN ASSEMBLY
4 LOCK WASHER 1/4
1 FLAT WASHER #8
1 SPACER
1 SCREW 8-32 X 5/8

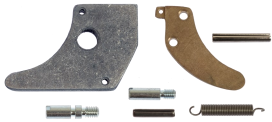

ITEM# 33373
LOCKING HEAD ASSY

USED IN: FRONT LIFTER
THIS KIT CONSISTS OF:
1 FINGER
1 TRIGGER
1 STUD SLOTTED
1 STUD NECKED
1 SPRING
1 PIN ROLL 156 0750
1 PIN LASHER

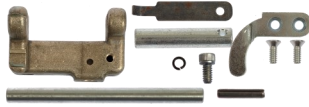

ITEM# 33372
SUPPORT CASTING KIT

USED IN: FRONT LIFTER
THIS KIT CONSISTS OF:
1 SUPPORT VERTICAL
1 CLIP LASHER
1 PIN 3/8 J2 LASHER
1 SPRING J2 LASHER
1 WA 10 LOK ST HI MD
2 SMCH 6-32X .37
1 PIN ROLL 156 0750
1 SCAP 10-24X .37
1 PIN J2 LASHER

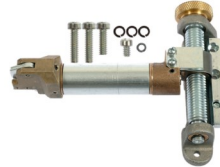

ITEM# 33291
REAR LIFTER COMPLETE

USED IN: REAR LIFTER
THIS KIT CONSISTS OF:
1 REAR LIFTER
1 WA 6 LOK ST ZN LT
3 WA 10 LOK ST HI MD
1 SMCH 10-24X .62
1 SMCH 6-32X .18 FI
2 SMCH 10-24X .75

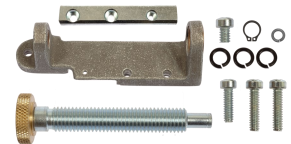

ITEM# 33374
BEARING BASE KIT

USED IN: REAR LIFTER
THIS KIT CONSISTS OF:
1 STOP BAR
1 WA 6 LOK ST ZN LT
3 WA 10 LOK ST HI MD
1 RING RETAINING
1 SMCH 10-24X .62
1 BEARING BASE
1 KNOB & SHAFT
1 SMCH 6-32X .18
2 SMCH 10-24X .75



ITEM# 33376
HEAD ASSEMBLY KIT

USED IN: REAR LIFTER
THIS KIT CONSISTS OF:
1 LATCH
1 LATCH HEAD
1 LATCH PAD
1 ROD 1/8
1 PLUNGER
2 PIN ROLL 062 0562
1 PIN ROLL 156 1000

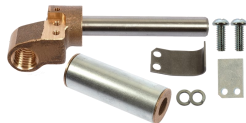

ITEM# 33375
THREADED FOLLOWER KIT

USED IN: REAR LIFTER
THIS KIT CONSISTS OF:
1 RETAINER SPRING
1 STOP RETAINER
1 FOLLOWER THREADED
2 WA 8 LOK
2 SMCH 8-32X .43 RD
1 ROLLER/BEARING

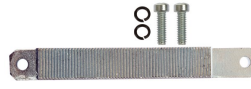

ITEM# 33287
FIXED PAD KIT

USED IN: REAR LIFTER
THIS KIT CONSISTS OF:
1 FIXED PAD
2 WA 10 LOK
2 SMCH 10-24X .62



ITEM# 33377
VERTICAL ASSEMBLY KIT

USED IN: VERTICAL GUIDE
THIS KIT CONSISTS OF:
1 ROLLER VERTICAL
1 CASTING LEFT
1 CASTING RIGHT
2 WA 10 LOK ST
2 3298 SMCH 10-24X .62
2 SMCH 250-20X .62
2 WA .250 LOK



J2 Cable Lasher Parts Identification Guide

Contact: GMP 3111 Old Lincoln Hwy Trevose, PA 19053 USA
Tel: (215) 357-5500 Fax: (215) 357-6216
www.GMPtools.com

Note: Some Images may appear larger than they are for clarity purposes.

KIT COMPONENTS

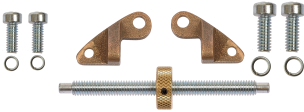

ITEM# 33371
MOUNTING BRACKET KIT

USED IN: VERTICAL GUIDE
THIS KIT CONSISTS OF:

- 1 CASTING LEFT
- 1 CASTING RIGHT
- 2 WA 10 LOK
- 2 SMCH 10-24X .62
- 2 SMCH 250-20X .62
- 1 KNOB SCREW ASSY
- 2 WA .250 LOK



ITEM# 33232
L.H. VERTICAL SUB ASSEMBLY

USED IN: VERTICAL GUIDE

THIS KIT CONSISTS OF:

- 1 CASTING LEFT
- 1 ROD 5/16D
- 1 CASTING LEFT
- 1 TUBE
- 1 CASTING LEFT
- 2 BEARING
- 1 SPRING
- 1 STUD 3/8D
- 1 PIN COTTER
- 2 PIN ROLL 125 0625
- 3 WA .281 FLT ST
- 1 PIN ROLL 125 0500



ITEM# 33231
R.H. VERTICAL SUB ASSEMBLY

USED IN: VERTICAL GUIDE

THIS KIT CONSISTS OF:

- 1 ROD 5/16D
- 1 CASTING RIGHT
- 1 CASTING RIGHT
- 1 TUBE J2 LASHER
- 1 CASTING RIGHT
- 2 BEARING OILITE
- 1 SPRING
- 1 STUD 3/8D
- 1 PIN COTTER
- 2 PIN ROLL 125 0625
- 3 WA .281 FLT ST
- 1 PIN ROLL 125 0500



J2 Cable Lasher Parts Identification Guide

Contact: GMP 3111 Old Lincoln Hwy Trevose, PA 19053 USA
Tel: (215) 357-5500 Fax: (215) 357-6216
www.GMPtools.com

Note: Some Images may appear larger than they are for clarity purposes.