

GMP C2 LASHER PARTS IDENTIFICATION GUIDE

for model series 71422

Effective January 9, 2024

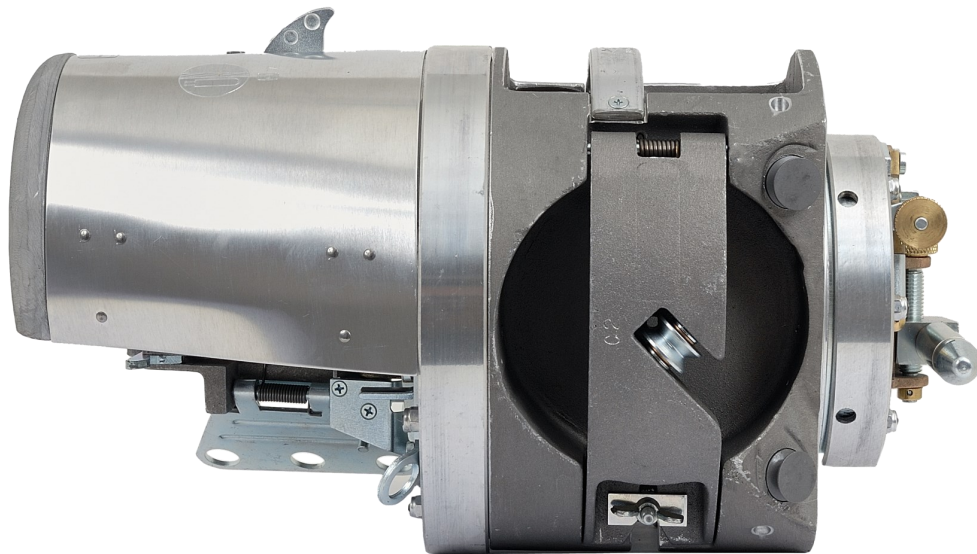

C2 Cable Lasher Parts Identification Guide
Contact: GMP 3111 Old Lincoln Hwy Trevose, PA 19053 USA
Tel: (215) 357-5500 Fax: (215) 357-6216
www.GMPtools.com

Note: Some Images may appear larger than they are for clarity purposes.

C2 parts kits and identification 01082024 V6a.pub
AK 1/9/2024

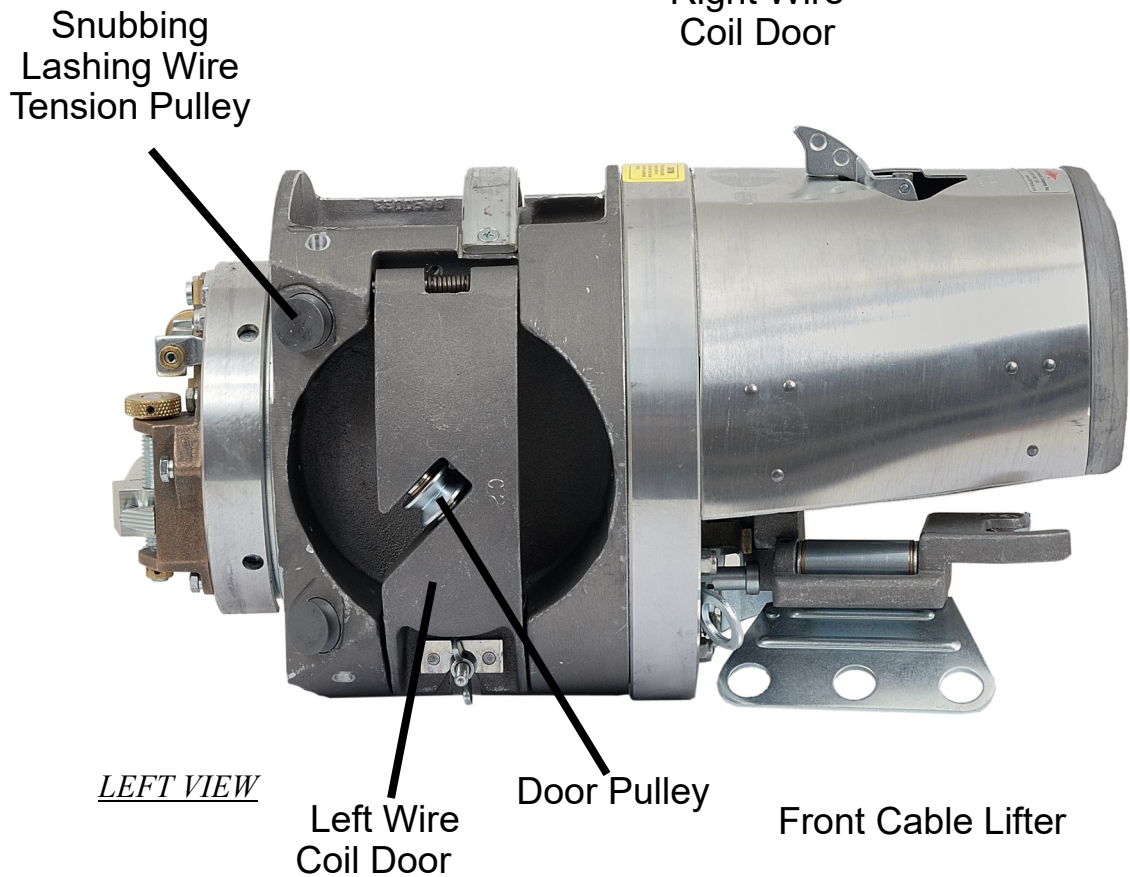
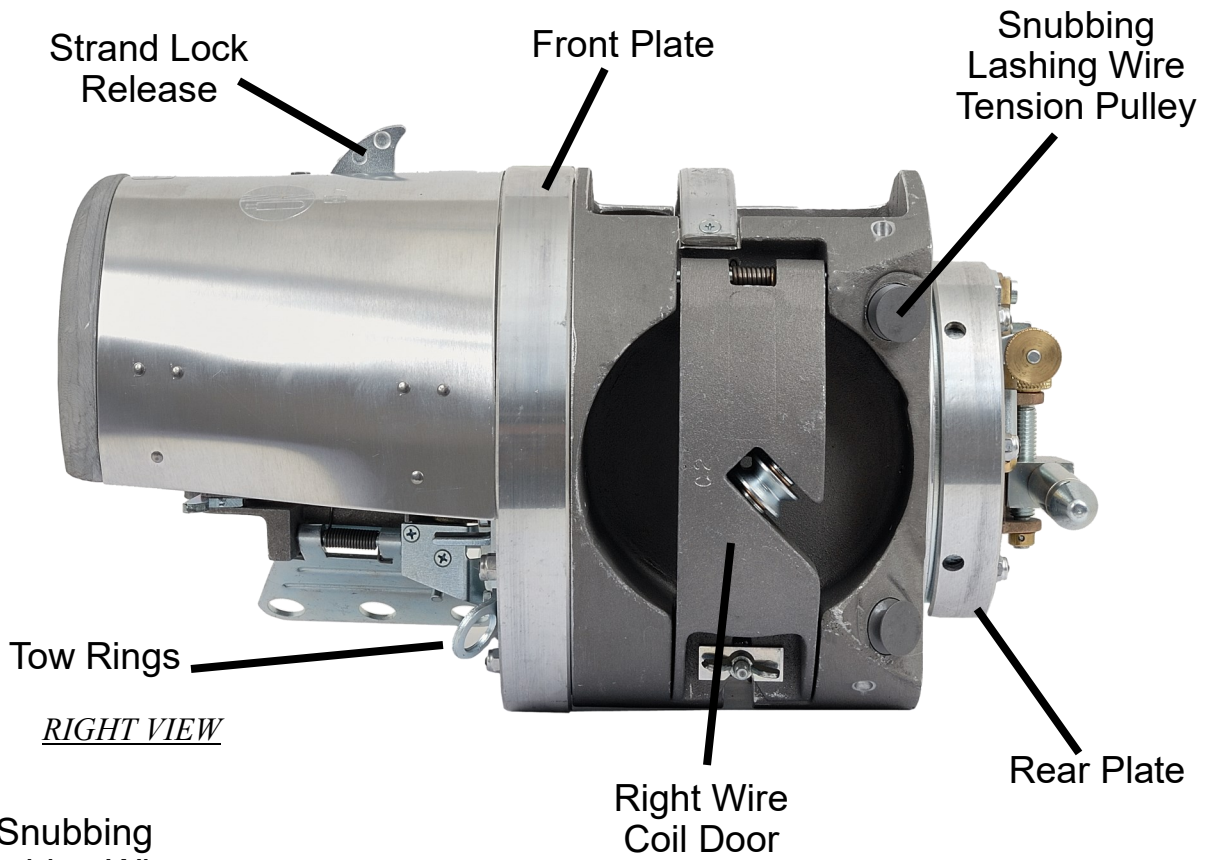

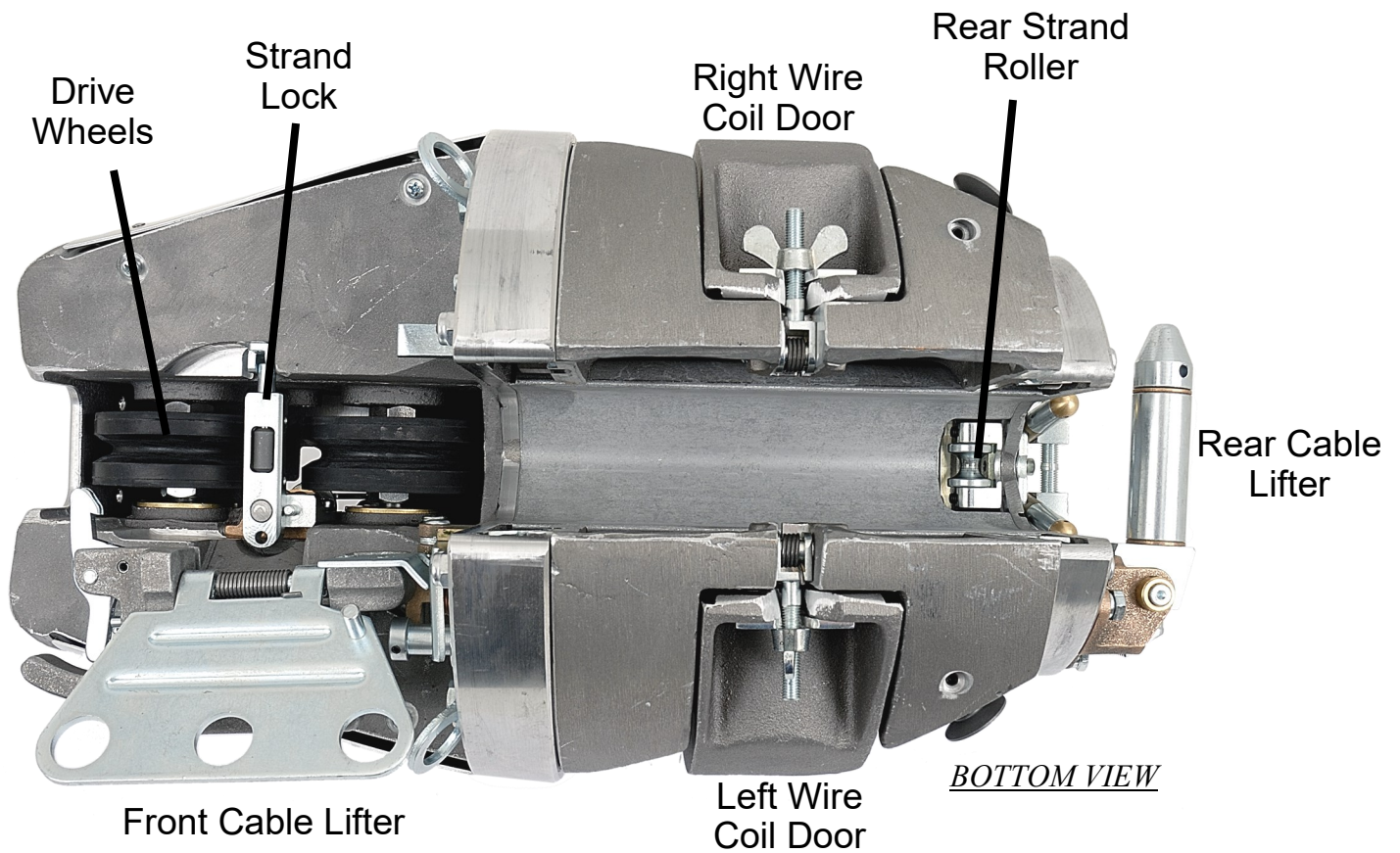
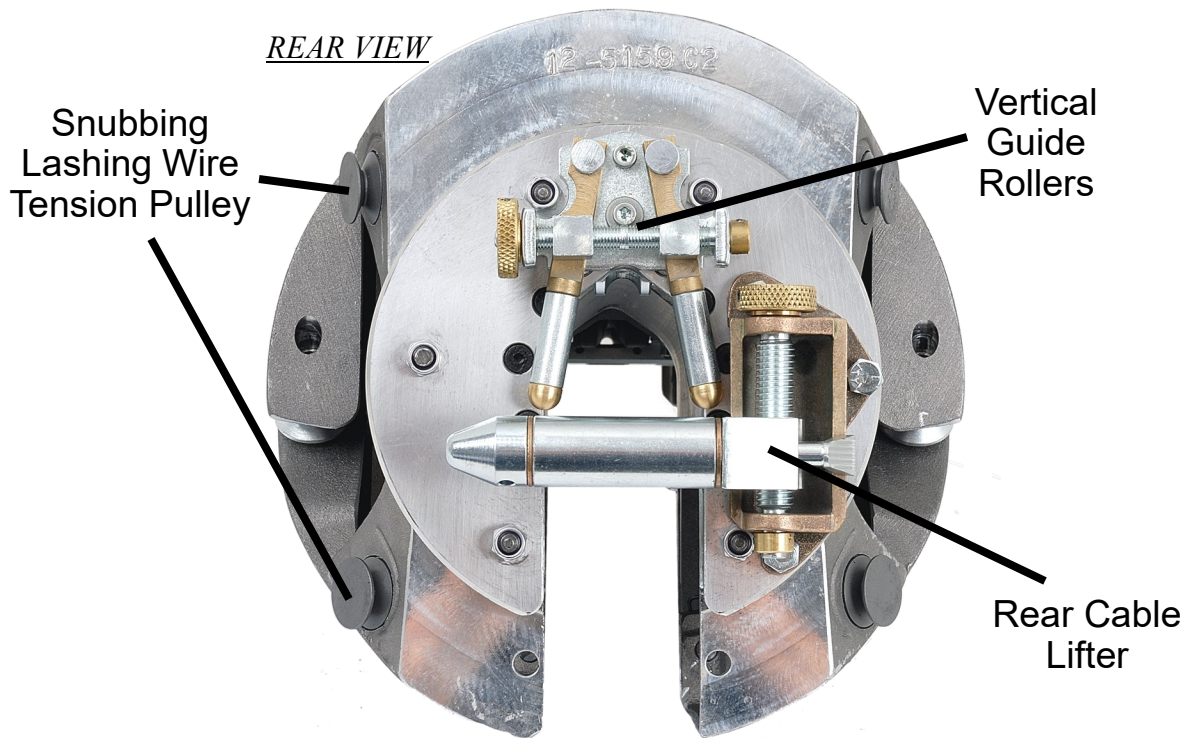

PARTS LOCATOR

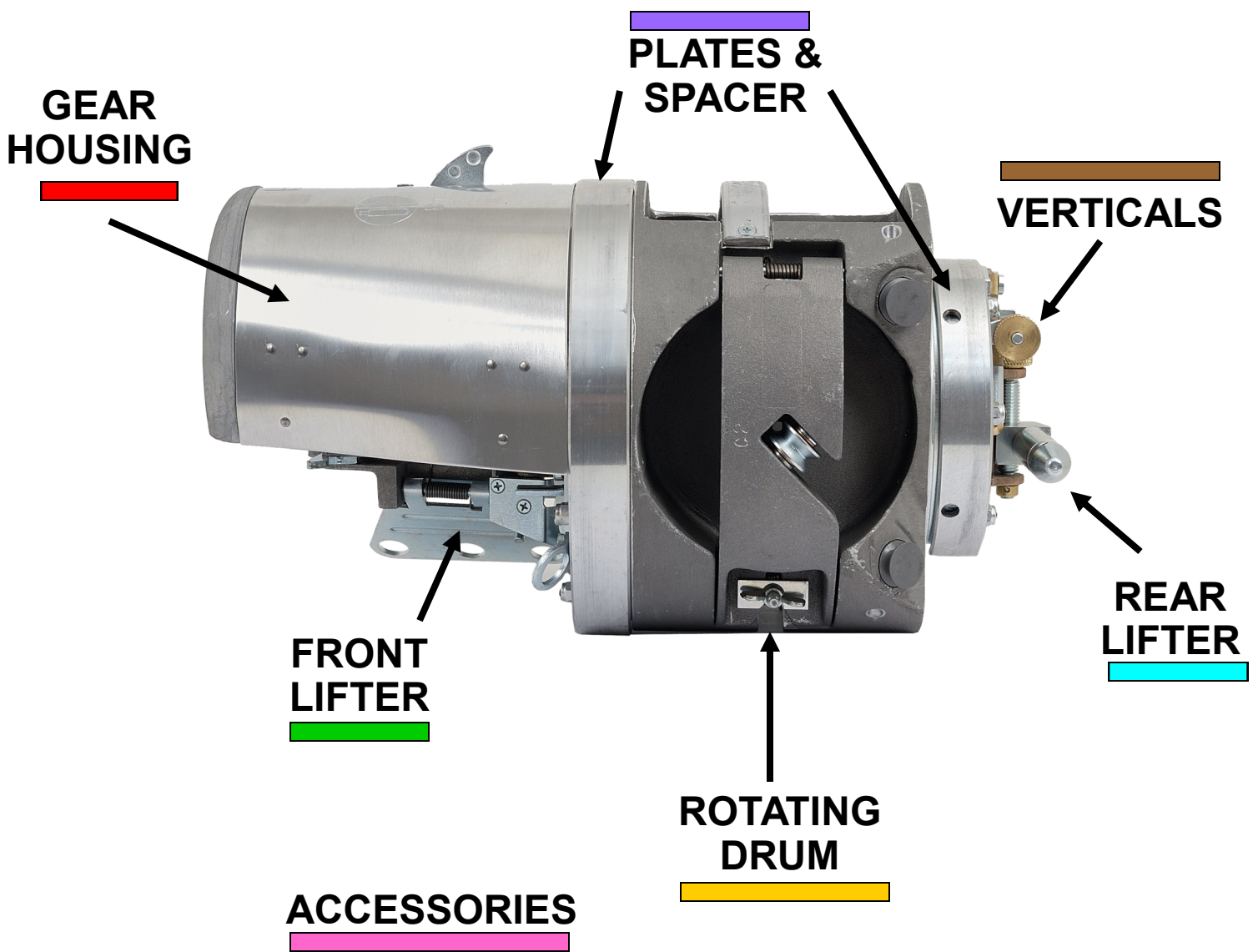



C2 LASHER GEAR HOUSING

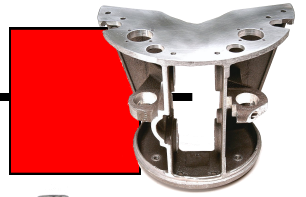

GEAR HOUSING - C2
p/n 35511

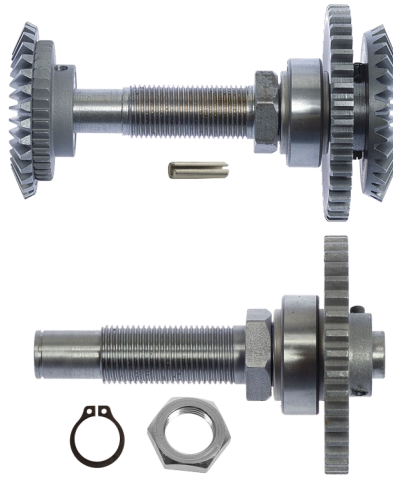

FRONT/REAR WHEEL
STRAND DRIVE - J2/C2
p/n 35482



PINION ASSY - C2
p/n 35495

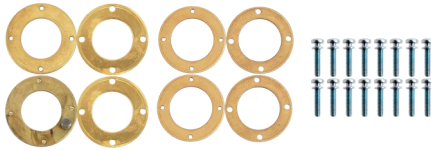

GEAR HOUSING BEARING/RETAING KIT
KIT - J2/C2 - p/n 35483



GEAR HOUSING COVER
C2 - p/n 33385

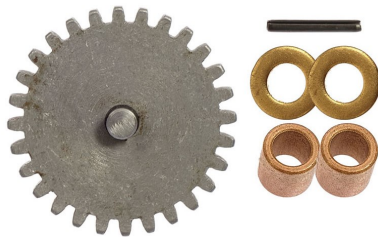

IDLER GEAR AND SHAFT
KIT - J2/C2 - p/n 33274



STRAND WHEEL KIT - J2/C2/C2
p/n 33359

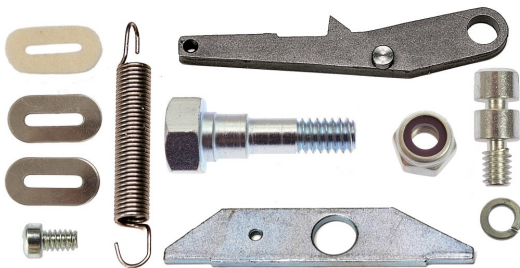

RATCHET KIT - C2
p/n 33387

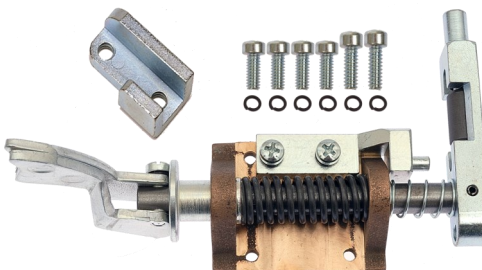

TENSION ROLLER KIT - C2
p/n 33388



HANDLE WITH INSERT - C2
p/n 38020



C2 Cable Lasher Parts Identification Guide

Contact: GMP 3111 Old Lincoln Hwy Trevose, PA 19053 USA
Tel: (215) 357-5500 Fax: (215) 357-6216
www.GMPtools.com

Note: Some Images may appear larger than they are for clarity purposes.

C2 parts kits and identification 01082024 V6a.pub
AK 1/9/2024



C2 LASHER ROTATING DRUM



HANDLE KIT - C2/C
p/n 33416

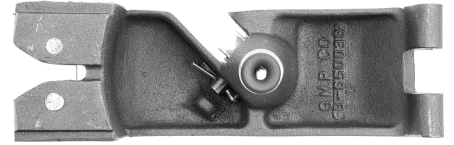
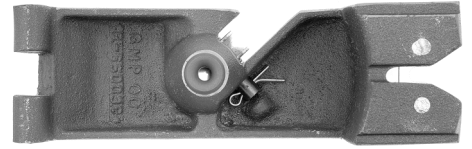

DOOR ASSY - C2/C
p/n 35496

NOTE: CASTING # ON DOOR IS B650038
AND B650039 on older units



SNUBBING PULLEY KIT -
J2/C2/C - p/n 33362

ROTATING DRUM ASSY
C2
p/n 35519

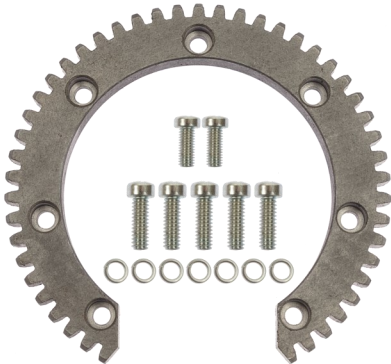

RING GEAR KIT - C2
p/n 33391

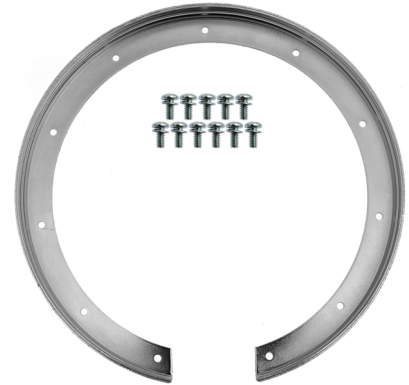
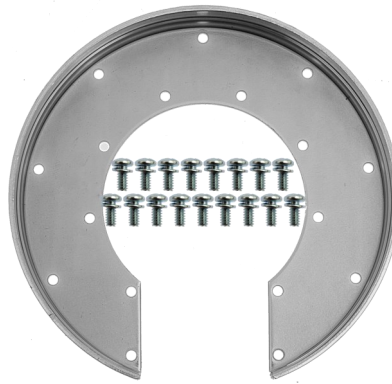

SMALL / LARGE RING KIT - C2
p/n 35497



SWING BOLT KIT - C2
p/n 34098

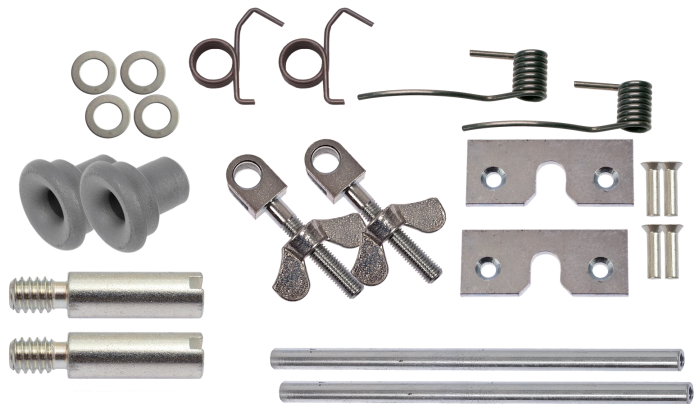

DOOR ACCESSORY KIT - C2
p/n 33407



C2 Cable Lasher Parts Identification Guide

Contact: GMP 3111 Old Lincoln Hwy Trevose, PA 19053 USA
Tel: (215) 357-5500 Fax: (215) 357-6216
www.GMPtools.com

Note: Some Images may appear larger than they are for clarity purposes.

C2 parts kits and identification 01082024 V6a.pub
AK 1/9/2024



C2 LASHER SPACER AND PLATES

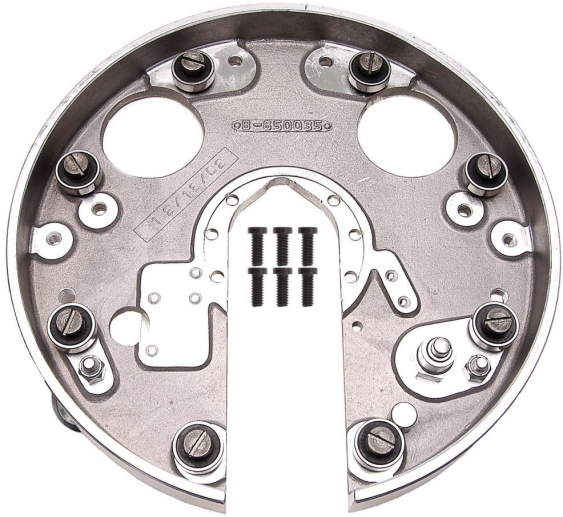
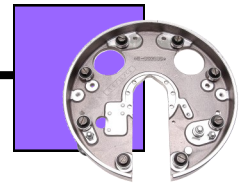

FRONT PLATE ASSY. - C2
p/n 27688

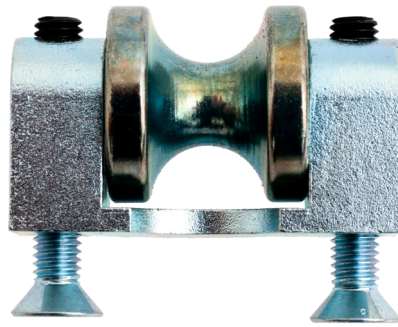

ROLLER STRAND KIT - C2/C
p/n 33393

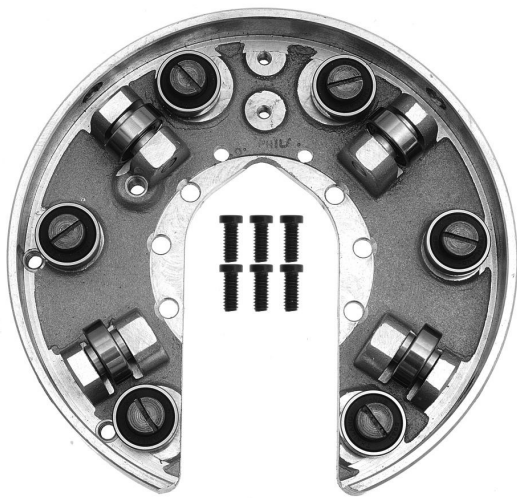

REAR PLATE ASSEMBLY - C2
p/n 27689

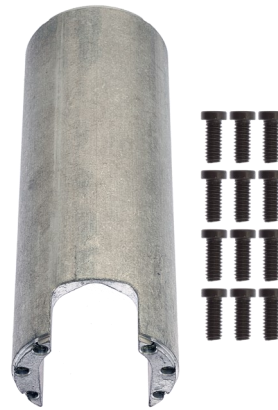

SPACER KIT - C2
p/n 33392



C2 Cable Lasher Parts Identification Guide

Contact: GMP 3111 Old Lincoln Hwy Trevose, PA 19053 USA
Tel: (215) 357-5500 Fax: (215) 357-6216
www.GMPtools.com

Note: Some Images may appear larger than they are for clarity purposes.

C2 parts kits and identification 01082024 V6a.pub
AK 1/9/2024



C2 LASHER FRONT / REAR LIFTER

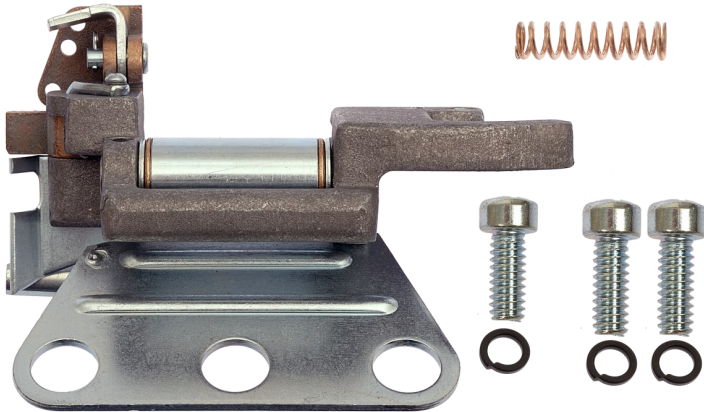
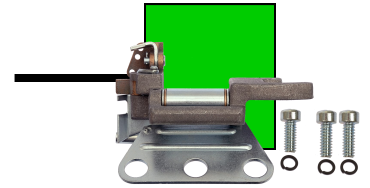

FRONT LIFTER ASSY COMPLETE. - C2
p/n 33397

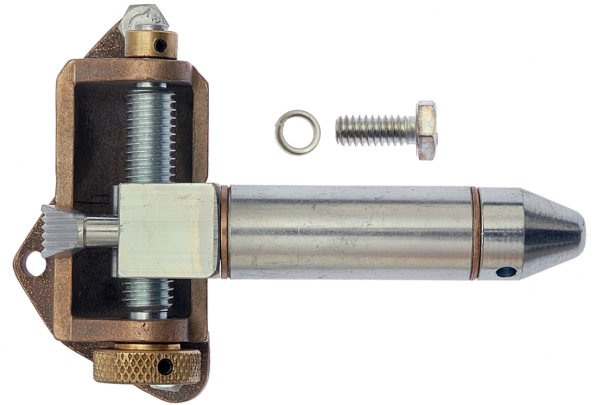

REAR LIFTER KIT COMPLETE - C2/C
p/n 33401

C2 LASHER VERTICAL GUIDE ROLLERS

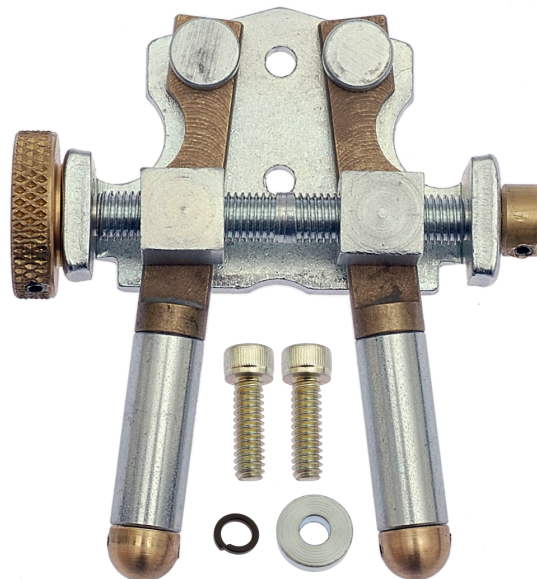
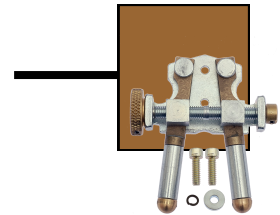

VERTICAL ROLLER KIT COMPLETE - C2
p/n 33404



C2 Cable Lasher Parts Identification Guide

Contact: GMP 3111 Old Lincoln Hwy Trevose, PA 19053 USA
Tel: (215) 357-5500 Fax: (215) 357-6216
www.GMPtools.com

Note: Some Images may appear larger than they are for clarity purposes.

C2 parts kits and identification 01082024 V6a.pub
AK 1/9/2024



C2 LASHER MISCELLANEOUS

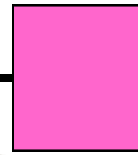

STORAGE AND TRANSPORT CHEST - C2
p/n 07143



Bridle Rope Assembly
P/N 03165



Towing Lanyard 35' Long
P/N 70190



C2 Cable Lasher Parts Identification Guide

Contact: GMP 3111 Old Lincoln Hwy Trevose, PA 19053 USA
Tel: (215) 357-5500 Fax: (215) 357-6216
www.GMPtools.com

Note: Some Images may appear larger than they are for clarity purposes.

C2 parts kits and identification 01082024 V6a.pub
AK 1/9/2024

KIT COMPONENTS



ITEM# 35511
DRIVE HOUSING ASSEMBLY
USED IN: C2 DRIVE HOUSING
THIS KIT CONSISTS OF:
1 P/N 03171 DRIVE HOUSING
2 P/N 17866 INSERT



ITEM# 35482
FRONT/REAR WHEEL STRAND DRIVE

USED IN: C2 DRIVE HOUSING
THIS KIT CONSISTS OF:
1 P/N 03013 RATCHET LASHER
1 P/N 03032 SHAFT 7/8 LASHER
1 P/N 03054 BEARING 88013
1 P/N 03318 PIN ROLL 156 1125
1 P/N 25011 GEAR BEVEL
1 P/N 25012 GEAR COMBINATION
1 P/N 03030 NUT
1 P/N 03277 RETAINING RING
1 P/N 07556 SHAFT ASSEMBLY



ITEM# 35495
R.H./L.H. PINION

USED IN: C2/C DRIVE HOUSING
THIS KIT CONSISTS OF:
2 P/N 34129 GEAR SPUR
2 P/N 34900 SHAFT LASHER
1 P/N 03036 COLLAR LASHER
3 P/N 03276 RETAINING RING
1 P/N 03288 SSET 8-32X .37 SK
2 P/N 03316 PIN ROLL 156 0875
1 P/N 25009 GEAR PINION BEVEL
1 P/N 03003 LATCH LASHER
1 P/N 34894 COLLAR LASHER
1 P/N 17850 SSET 8-32X .18 SK
1 P/N 25010 GEAR PINION
1 P/N 09131 PIN ROLL



ITEM# 35483
BEARING AND RETAINING RING KIT

USED IN: C2 DRIVE HOUSING
THIS KIT CONSISTS OF:
1 P/N 03022 COVER WASHER
2 P/N 03023 COVER WASHER
2 P/N 03024 COVER WASHER
2 P/N 03025 COVER WASHER
16 P/N 03260 WA 5 LOK ST ZN
16 P/N 03291 SMCH 5-40X .62
1 P/N 03328 PLATE STOP
2 P/N 03054 BEARING 88013
4 P/N 03055 BEARING 88500

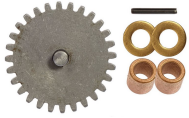

ITEM# 33274
IDLER GEAR AND SHAFT KIT

USED IN: J2/C2/C DRIVE HOUSING
THIS KIT CONSISTS OF:
2 P/N 03056 BEARING OILITE
1 P/N 03309 PIN ROLL .094 0500
1 P/N 07565 SHAFT & GEAR
2 P/N 16692 WASHER .265 FLT

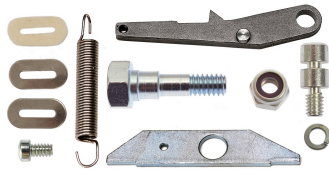

ITEM# 33387
RATCHET KIT

USED IN: C2 DRIVE HOUSING
THIS KIT CONSISTS OF:
2 p/n 03016 SPACER
1 p/n 03017 WIPER
1 p/n 03037 SPRING
1 p/n 03040 SCREW NECKED
1 p/n 03263 WA 8 LOK ST ZN MD
1 p/n 17835 NT .250-20 HX ST
1 p/n 27686 LINK C2 LSHR
1 p/n 27826 SCREW ECCENTRIC
1 p/n 28247 LATCH/PIN ASSEMBLY
1 p/n 31306 SMCH 4-40X .18 FI



ITEM# 33385
GEAR HOUSING COVER KIT

USED IN: C2 DRIVE HOUSING
THIS KIT CONSISTS OF:
4 p/n 31315 SMCH 10-32X1.25 FI
1 p/n 27692 COVER

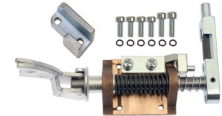

ITEM# 33388
TENSION ROLLER KIT

USED IN: C2 DRIVE HOUSING
THIS KIT CONSISTS OF:
6 p/n 03265 WA 10 LOK ST HI MD
1 p/n 27677 STOP STRAND ROLLER
1 p/n 27682 TENSION STRAND ASSY
2 p/n 31314 SMCH 10-24X .87 FI ST
4 p/n 31316 SMCH 10-32X .50 FI ST



ITEM# 33359
STRAND DRIVE WHEEL KIT

USED IN: J2/C2/C DRIVE HOUSING
THIS KIT CONSISTS OF:
2 p/n 03039 NT BLOCK SPEC
2 p/n 28115 STRAND DRIVE WHEEL
4 p/n 28116 WA CLAMPING



ITEM# 35519
ROTATING DRUM ASSY

USED IN: C2 ROTATING DRUM
THIS KIT CONSISTS OF:
1 p/n 03287 SSET 8-32X .31
1 p/n 04739 BUSHING
1 p/n 07006 DRUM ROTATING



ITEM# 33362
SNUBBING PULLEY KIT

USED IN: J2/C2/C ROTATING DRUM
THIS KIT CONSISTS OF:
4 p/n 03288 SSET 8-32X .37
4 p/n 26055 PULLEY ASSY



ITEM# 27688
FRONT PLATE ASSY

USED IN: C2 PLATES/SPACER
THIS KIT CONSISTS OF:
1 p/n 02020 BAR CATCH
2 p/n 02021 RING PULL
1 p/n 02022 CUP
1 p/n 03086 SLEEVE LASHER
1 p/n 03087 NT LOCKING BOLT RETAINER
1 p/n 03089 SPRING 11/32ID X 1 1/2 MUSIC
1 p/n 03090 BUSHING
8 p/n 03091 SCREW ECCENTRIC
4 p/n 03265 WA 10 LOK ST HI MD
8 p/n 03273 NT .250-28 HX ST
4 p/n 03298 SMCH 10-24X .62 FI ST S ZN
1 p/n 03311 PIN ROLL 59 028 125 0625
1 p/n 05918 SCAP 250-28X1.00 HX ST ZN
1 p/n 25144 BRACKET H LASHER
8 p/n 26051 BEARING
16 p/n 26052 SPACER BEARING
1 p/n 27675 PLATE FRONT
6 p/n 28033 SCAP 250-20X.62 SK ST A BO

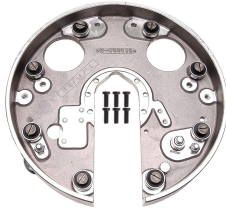

ITEM# 27689
REAR PLATE ASSEMBLY

USED IN: C2 PLATES/SPACER
THIS KIT CONSISTS OF:
6 p/n 03091 SCREW ECCENTRIC
6 p/n 03273 NT .250-28 HX
4 p/n 25158 SCREW SPEC
10 p/n 26051 BEARING RAD608D
20 p/n 26052 SPACER BEARING
1 p/n 27685 PLATE REAR
6 p/n 28033 SCAP 250-20X.62 SK



ITEM# 33416
HANDLE KIT
USED IN: J2/C2/C DRIVE HOUSING
THIS KIT CONSISTS OF:
2 p/n 03269 SMCH 10-24X .75
1 p/n 04736 HANDLE



ITEM# 38020
HANDLE WITH INSERT - C2

USED IN: C2
THIS KIT CONSISTS OF:
1 HANDLE WITH INSERT
2 5/16 x 18 THUMB SCREWS



C2 Cable Lasher Parts Identification Guide

Contact: GMP 3111 Old Lincoln Hwy Trevose, PA 19053 USA
Tel: (215) 357-5500 Fax: (215) 357-6216
www.GMPtools.com

Note: Some Images may appear larger than they are for clarity purposes.

KIT COMPONENTS

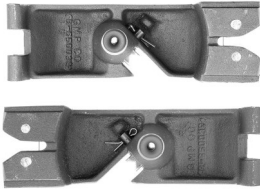

ITEM# 35496
R.H./L.H. DOOR ASSY

USED IN: C/C2 DRIVE HOUSING
THIS KIT CONSISTS OF:
2 P/N 34985 TUBE LASHER
2 P/N 34895 PULLEY LASHER
4 P/N 03066 BEARING LOWER
2 P/N 34882 BUSHING
2 P/N 35251 PLATE LASHER
4 P/N 03069 WA .387
2 P/N 03257 PIN COTTER
1 P/N 34126 COIL DOOR
4 P/N 09389 RVT .125X .625
1 P/N 34123 COIL DOOR

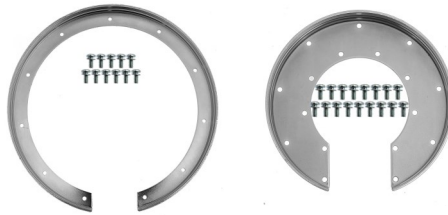

ITEM# 35497
SMALL /LARGE RING KIT

USED IN: C2 DRIVE HOUSING
THIS KIT CONSISTS OF:
1 p/n 27672 RING BEARING LARGE
1 p/n 27673 RING BEARING SMALL
28 p/n 31309 SMCH 6-32X .31



ITEM# 33407
DOOR ASSY KIT

USED IN: C2/C DRIVE HOUSING
THIS KIT CONSISTS OF:
2 p/n 03067 BUSHING WIRE COIL
2 p/n 03068 PLATE LASHER
4 p/n 03325 WA .387 FLT ST
2 p/n 04734 PIN HINGE THUMB
2 p/n 04735 SPRING
2 p/n 04737 SPRING DOOR
2 p/n 04803 TUBE
2 p/n 07547 BOLT WING NUT
4 p/n 16301 RVT .125X .625

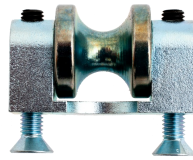

ITEM# 33393
ROLLER STRAND KIT

USED IN: C2/C PLATES/SPACER
THIS KIT CONSISTS OF:
1 p/n 02026 PIN 3/16
1 p/n 02029 HOLDER
2 p/n 03370 SSET 10-32X .25
1 p/n 25145 ROLLER STRAND
2 p/n 31324 SMCH 10-32X .62



ITEM# 33392
SPACER KIT

USED IN: C2 PLATES/SPACER
THIS KIT CONSISTS OF:
1 p/n 27676 SPACER C2 LASHER
12 p/n 28033 SCAP 250-20X .62

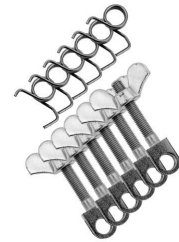

ITEM# 34098
SWING BOLT KIT

USED IN: C2/C DRIVE HOUSING
THIS KIT CONSISTS OF:
6 SPRINGS
6 WING BOLT NUT ASSY

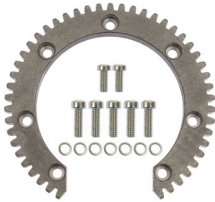

ITEM# 33391
RING GEAR KIT

USED IN: C2 DRIVE HOUSING
THIS KIT CONSISTS OF:
2 p/n 03303 SMCH 250-20X .50
5 p/n 03305 SMCH 250-20X .75
7 p/n 16005 WA .250 LOK
1 p/n 27674 RING GEAR

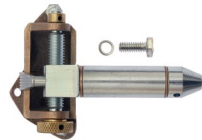

ITEM# 33401
REAR LIFTER KIT COMPLETE

USED IN: C/C2 REAR LIFTER
THIS KIT CONSISTS OF:
1 p/n 03408 LIFTER REAR
1 p/n 16005 WA .250 LOK
1 p/n 28090 SCAP 250-20X .875

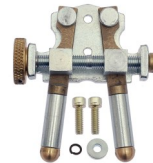

ITEM# 33404
VERTICAL ROLLER KIT

USED IN: VERTICAL GUIDE
THIS KIT CONSISTS OF:
1 p/n 03265 WA 10 LOK
2 p/n 16213 SCAP 10-24X .62
1 p/n 27698 ROLLER VERT
1 p/n 28032 SPACER VERT

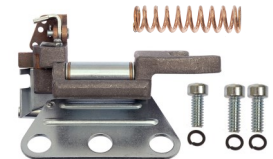

ITEM# 33397
FRONT LIFTER ASSEMBLY

USED IN: FRONT LIFTER
THIS KIT CONSISTS OF:
3 p/n 03265 WA 10 LOK ST HI
1 p/n 27691 GATE FRONT ASSY
2 p/n 31312 SMCH 10-24X .62
1 p/n 31316 SMCH 10-32X .50

