

GMP Breeze Configuration for Cable Blowing

In order to customize your new "Breeze" to your application, we ask that you pick, one each from the lists below, the Tube Collet Assembly P/N, the Cable Guide Assembly P/N and the Cable Collet Assembly P/N. When ordering, please have Tube and Cable dimensions available.

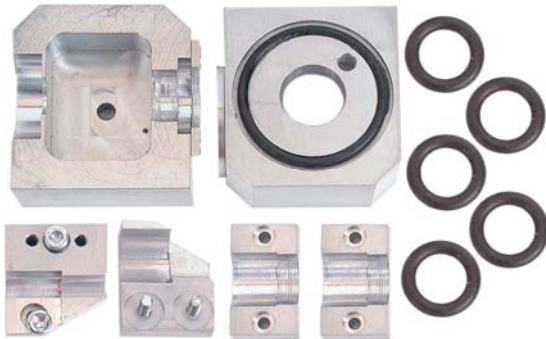

Spare Airbox Top Seal
P/N 89525 (5 pack)



Tube Collet Assembly

Tube O.D	P/N
4 mm	89545
5 mm	89539 (1)
6 mm	89546
7 mm	89547
8 mm	89540
8.5 mm	89537
10 mm	89541
12 mm	89542
12.7 mm	89543
14 mm	89538
16 mm	89544
18 mm	89536

Duct Seals
89556 (5 pack)
89549 (5 pack)
89557 (5 pack)
89553 (5 pack)
89550 (5 pack)
89550 (5 pack)
89551 (5 pack)
89552 (5 pack)
89552 (5 pack)
89555 (5 pack)
89554 (5 pack)
89558 (5pack)

(1) For blown fiber conversion, see GMP P/N 89592



Cable Guide Set

Cable Size	P/N
2.5 - 3.8 mm	89520
3.8 - 8.5 mm	89521 (2)

(2) GMP P/N 89521 Required for blown fiber conversion.

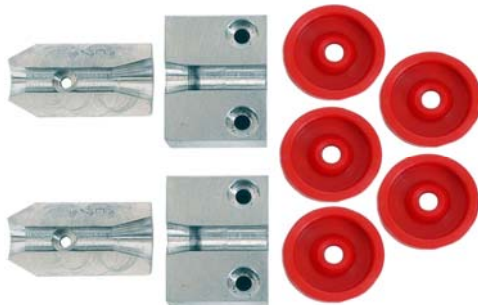

Cable Collet Assembly

Cable Size	P/N
2.0 - 2.5 mm	89528 (3)
2.5 - 3.0 mm	89530
3.0 - 3.8 mm	89531
3.8 - 5.0 mm	89532
5.0 - 6.4 mm	89533
6.4 - 8.0 mm	89534
8.0 - 8.5 mm	89535

Cable Seals
89509 (5 pack)
89510 (5 pack)
89511 (5 pack)
89512 (5 pack)
89513 (5 pack)
89514 (5 pack)
89515 (5 pack)

(3) Includes long cable guides not shown.



General Machine Products (KT), LLC 3111 Old Lincoln Highway Trevose, PA 19053 USA
Tel: +1.215.357.5500 Fax: +1.215.357.6216 Email: info@GMPtools.com

GMP Breeze Configuration for Cable Blowing

Replacement Hardware

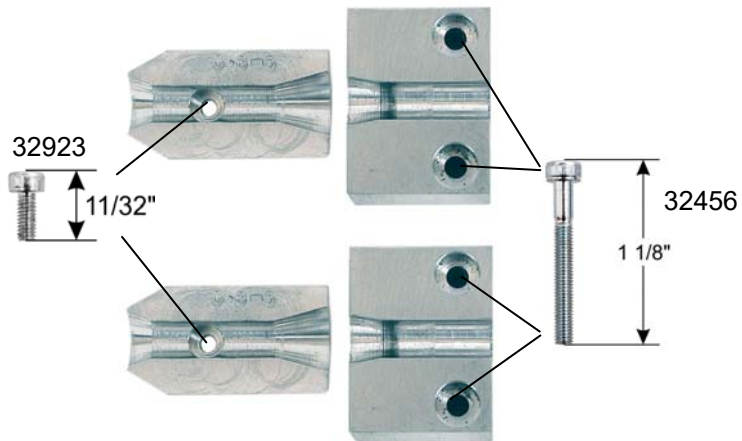
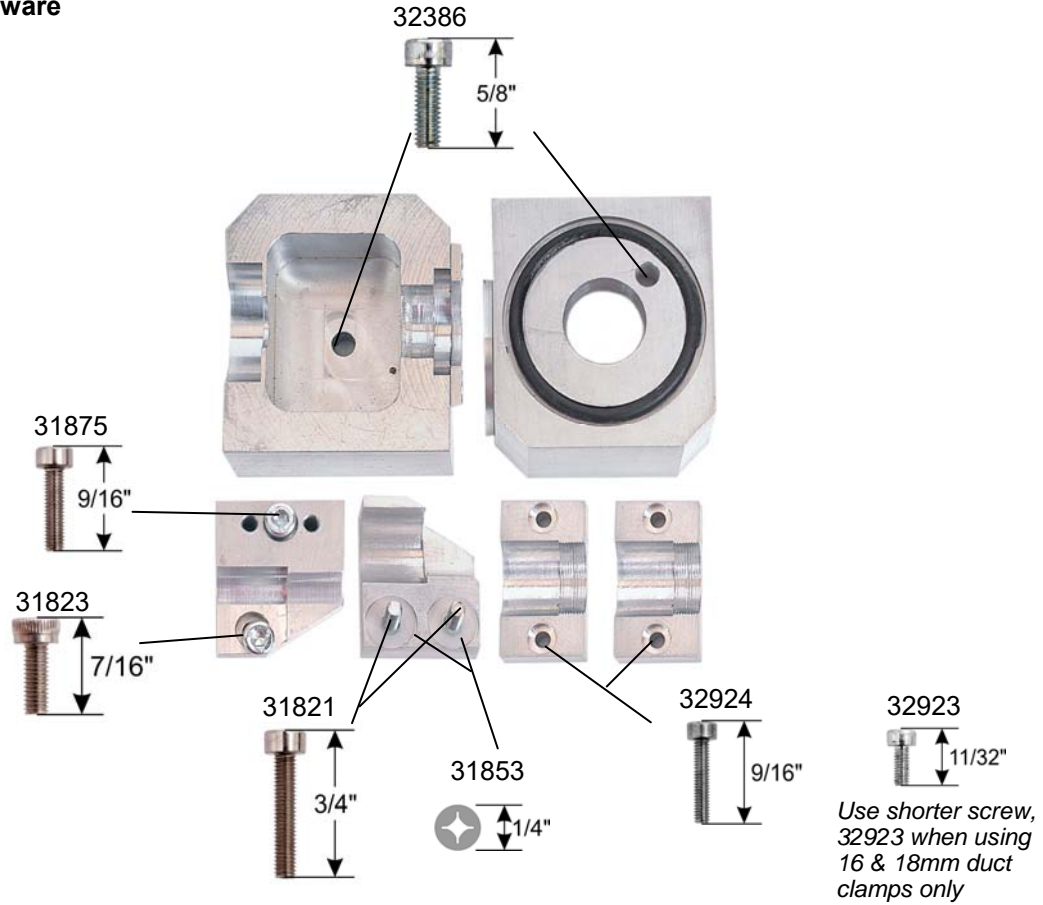

GMP Breeze Configuration for Cable Blowing

In order to customize your new "Breeze" for Blown fiber, the kit below is required. The cable guide, P/N 89521, is required, but is sold separately.



Blown Fiber Conversion P/N 89592

Duct Size 5mm
Fiber Size 1.1mm, 1.6mm and 2.0mm diameter



Infeed Guide Set
32878



Infeed Guide Insert Set
32877

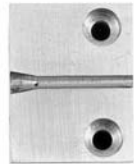

Seal Guide Half Set
32876

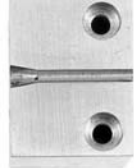
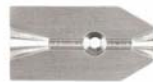

Drive Wheel Set
89589

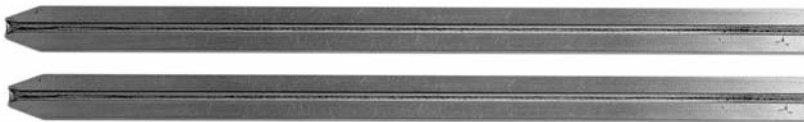

Cable Guide Set
32875



Solid Cable Guide
1.1mm 33087
1.6mm 33043
2.0mm 33425

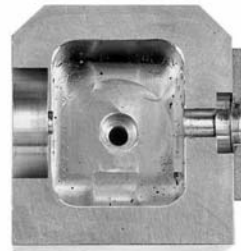

Airbox Set
32879



Micro Duct Seals
89549 5/pk



Duct Clamp Set
32874



Solid Plug
89548 5/pk

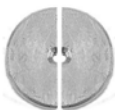

Optional Split Cable Guide
1.1mm 33090
1.6mm 33091
2.0mm 33426

Helpful Tip



To keep from losing the split cable seal, attach a small piece of thin, double backed tape to the bottom. The seal will stay together and in place when you open the airbox.



GMP Breeze Configuration for Cable Blowing

Metal Drive Wheel Kit

Under certain conditions, e.g. in series blowing where lubricant is used, knurled metal drive wheels offer increased grip on the cable.



The kit contains a pair of knurled stainless steel drive wheels and a spring loaded mechanism which allows the drive to compensate for variances in cable diameter while applying a consistent force.



Metal Drive Wheel Kit
P/N 89692 Weight: 2.5 lbs. (1.1 kgs)

Accessory Air Hose

Complete with blow gun and Chicago fitting for direct connection to compressor.



P/N 89423
Weight: 2.3 lbs. (1 kg)

Blown Fiber Beads

Beads are crimped on the end of the blown fiber to help the guidance of the blown fiber through the microduct. Also reduces the risk of snagging at the connector locations. Sold in packs of 25.



P/N 89723 1.6 Ø Blown Fiber
P/N 89724 1.1 Ø Blown Fiber
Weight: 2 oz. (56g)

Breeze Bottled Nitrogen Kit for Blown Fiber

- Used with bottled nitrogen in place of a compressor for 5mm or smaller Microduct
- Quickly connects to the Breeze hose via a twist lock connector.
- Hose is 12 1/2 feet long for easy setups.
- The regulator has easy to read 2" gauges.
- The flexible hose is abrasion, weather and ozone resistant.
- Inlet connection is CGA 580.



CGA 580:
.965"-14 NGO-RH-INT



Do Not Exceed the Hose Rating of 200 PSI.

Breeze Bottled Nitrogen Kit
P/N 89743 Weight: 5.5 lbs. (2.5 kgs)

